

Celestron 11/14

OPERATING \$1.00  
MANUAL

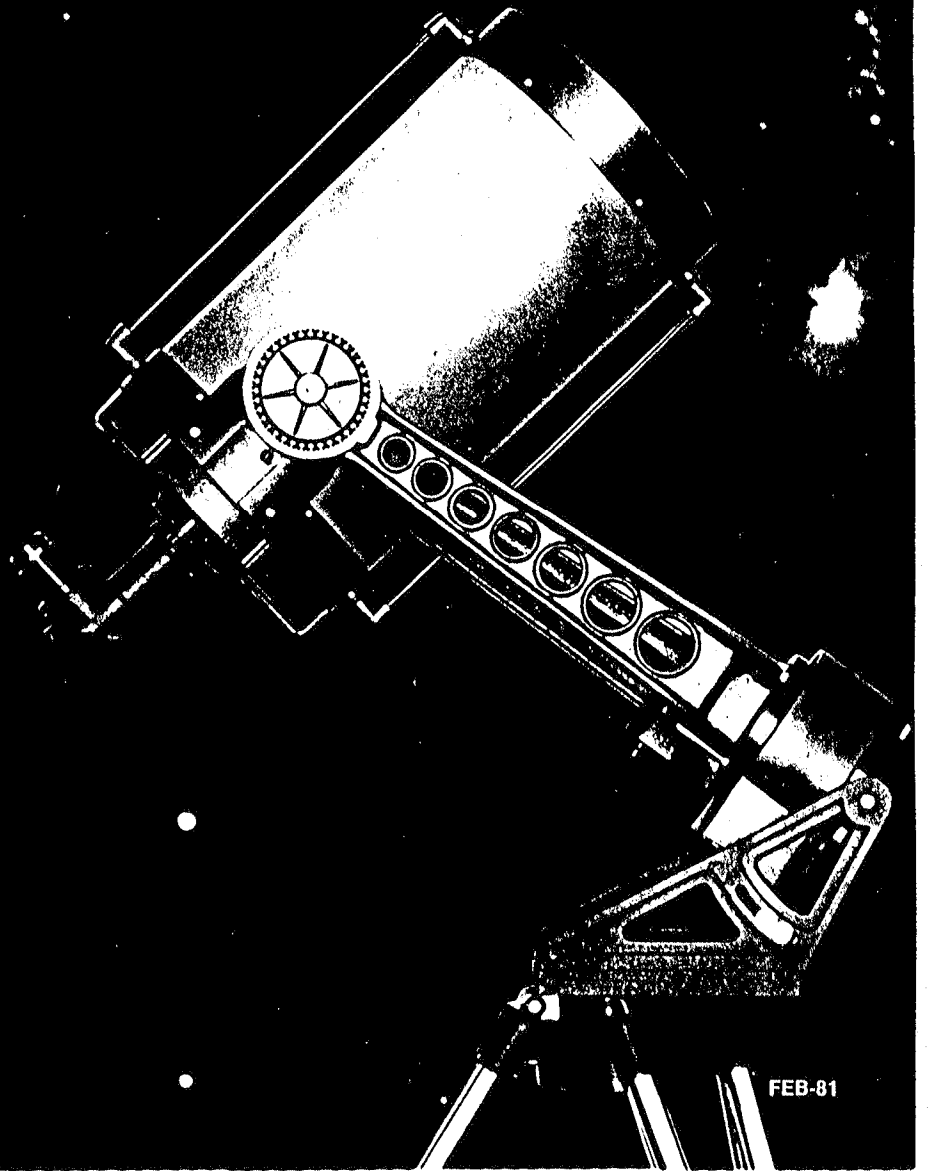

**Celestron International**

2835 Columbia Street • Box 3578 • Torrance, CA 90503 • USA  
Phone (213) 328-9560

FEB-81

TABLE OF CONTENTS

The Basic Celestron	4
Optional Special Coatings	4
Basic Assembly of Your Telescope	4
Setting Up Your Tripod	4
The Equatorial Wedge	4
Attaching the Drive Base	5
Installing the Tube Assembly	5
The Finderscope/Optional Finderscopes	5
The Star Diagonal	6
Your First Look	6
Hints for the Casual Observer	7
Magnification	7
Multiple Ocular Holder	7
The Barlow Lenses	7
The Most Useful Powers	7
The RFA/2" Oculars	8
The Electric Clock Drive	8
The C14 Electric Slow-Motion Controls	8
Setting Your Dec. Setting Circles	9
The Celestial Coordinate System	9
Lining Up on the Pole	9
Precise Polar Alignment for Astrophotography	10
Using Your Setting Circles	10
Using Your Celestron/Temperature Differences	11
Using the Counterweights	12
Observing With Your Celestron	12
Observing the Sun	14
Eyepiece Thread-In Filters	14
Filter Adapters/Adapter Bushings	14
LPR Filters/Polarizing Filters	15
Photography With Your Celestron	15
Solar Photography/Lunar Photography	15
Terrestrial Photography	16
Lunar and Planetary Photography	17
Deep Sky Photography	17
Constellation ("Piggyback") Photography	17
The Off-Axis Guiding System	18
Photographic Guide Scopes/Celestron Tangent Assembly	19
Drive Correctors/DC Inverter	20
The C11 Optional Declination Motor/Dual-Axis	20
The Tele-Compressor	20
The Cold Camera	20
Large Aperture Telescopes and Electronic Image Intensifiers/Schmidt Cameras	21
The Permanent Pier	22
The T-C Video/Movie Camera Adapter	22
Caring for Your Celestron/Collimation	22
Lens Care and Cleaning	23
Demounting the Optics	24
Adjusting the R.A. Clamp/Dec. Clamp	24
Adjusting the Dec. Slow-Motion	24
Adjusting Worm Gear Drives	25
Returning Your Instrument for Service	25
APPENDICES:	
Appendix I—Basic C11 Telescope Specifications	26
Appendix II—Basic C14 Telescope Specifications	27
Appendix III—The Messier Catalog	28
Appendix IV—Alphabetical Listing of Bright Stars	29
Appendix V—C11 Eyepiece Reference Table	29
Appendix VI—C14 Eyepiece Reference Table	30
Appendix VII—Recommended Reading	31
Appendix VIII—Observatory Dome Manufacturers	31
Appendix IX—C11/C14 Permanent Pier Plans	31

Front Cover Photo: Celestron 14 mounted on equatorial wedge and tripod. Back Cover Photos shot with Celestron 14. Printed in U.S.A. All rights reserved.

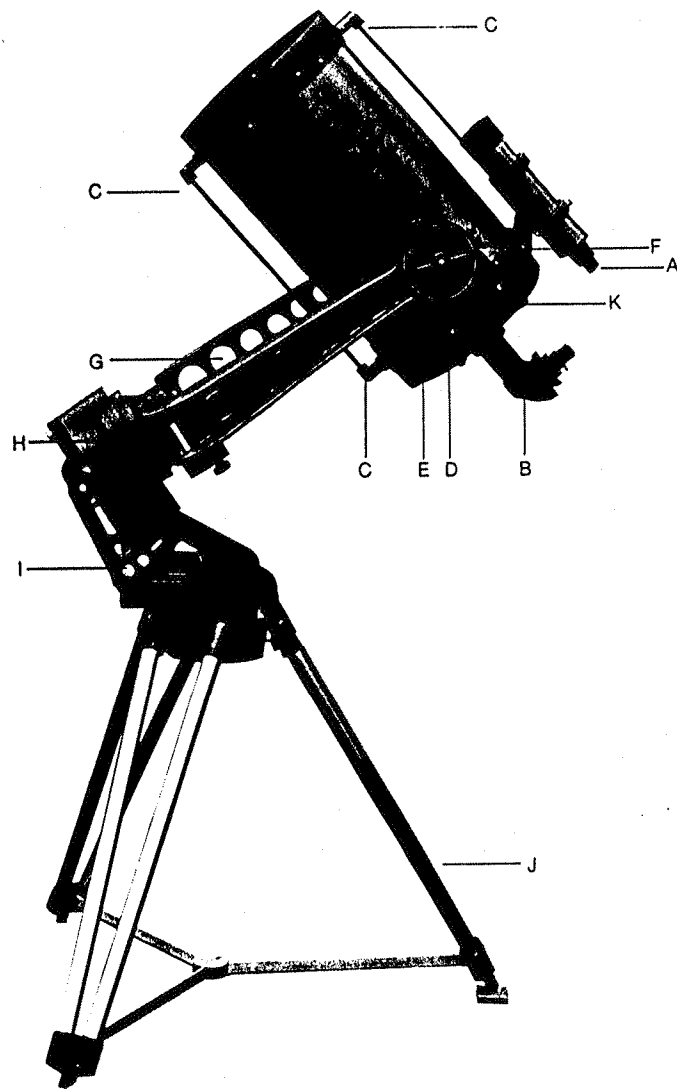

*The Basic Celestron*

(A) Finderscope (B) Star diagonal (C) Counterweight brackets (D) Rear cell (E) Declination setting circle (F) Declination clamp (G) Fork line (H) Drive base (I) Wedge (J) Tripod (K) Declination saddle arm. The C14 is pictured here; the C11 has corresponding parts.

NOTE: This manual is for the operation of both the C11 and the C14. These two large aperture telescopes have similar component nomenclature and use most of the same accessories. The major difference between the C11 and the C14, besides the larger aperture of the C14, is the lack of (standard) electric slewing motors on the C11.

### The Basic Celestron

Inside the larger of the two carrying cases, you'll find the optical tube assembly. Inside the smaller case you'll find the fork mount and drive assembly, hardware and wrench set, drive cord, star diagonal, oculars, visual back, T-adaptor, tele-extender, 2 counterweights, piggyback camera mount, 10x40 finderscope and bracket (and with the C14: an illuminator lamp and cord, electric hand control box, 2-inch ocular adapter and mounting hardware).

As you encounter references to these and other components of your Celestron 11 or 14, consult the illustration on page 3, or check detail illustrations in the appropriate sections of this manual.

### Optional Special Coatings

The special coatings consist of magnesium fluoride anti-reflection coatings on both sides of the Schmidt corrector plate. These coatings increase light transmission and contrast slightly and ensure that you'll get the maximum performance from your Celestron. The coating is as durable as the coating on a fine camera lens and will last a lifetime if given reasonable care (see the section on "Lens Care and Cleaning"). If you ordered these optional coatings, the C11/C14 tube will have a special coating label. Also, the Schmidt corrector will have the characteristic tan to bluish tint of MgF<sub>2</sub>.

### Basic Assembly of Your Telescope

#### (1) Setting Up Your Tripod.

The Celestron Locked-Triangle Tripod is offered as an optional accessory for those who require the ultimate in stability from a portable tripod. It is designed for maximum stability and provides a convenient height for seated observing and photography.

To set up your tripod, stand it on its head, remove the elastic band and let down the legs one by one, making sure the tensioner bars remain under the legs. Grasp two of the legs near the tripod head and lift upward. The tensioner bars will move toward each other. When they meet, open the lock plate of the tensioner coupler and hook the tensioner bars into the slots in the coupler.

Tension adjustments are provided for your tripod. To increase the tension, advance the Allen-head bolts in the cross bars at the top of the tripod legs and re-tighten the lock nuts.

#### (2) The Equatorial Wedge

If you ordered the equatorial wedge, it will come assembled and set to the latitude of your location (to the nearest degree). Please specify the latitude when ordering.

To mount the wedge on the Celestron tripod, center the three holes in the wedge base over the three holes in the tripod head, and thread in the three 3/8-16x1 1/4 bolts.

The equatorial wedge is supplied with a latitude adjusting bar to make small adjustments in elevation easy to accomplish. Fine adjustments will normally be made when the entire telescope is assembled and mounted on the wedge and tripod. First, position the adjusting screws on the latitude bar up against the tilt plate. This will prevent the wedge and telescope from moving until you're ready to adjust it. Now loosen the tilt plate bolts on each side of the wedge. You may now use the small adjusting screws in the latitude adjusting bar for making

small adjustments. The bottom of the tilt plate describes an arc as it moves between the sides of the wedge. This movement will permit you to tilt the polar axis of your Celestron so that it points to the North Celestial Pole. (Refer to the section on "Lining Up on the Pole"). After the adjustments are completed, re-tighten the two bolts on each side of the wedge.

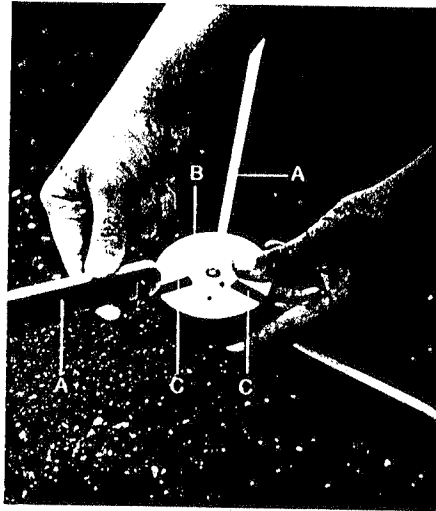

The Locked-Triangle Tripod

(A) Tensioner bars (B) Lock Plate (C) Coupler slots

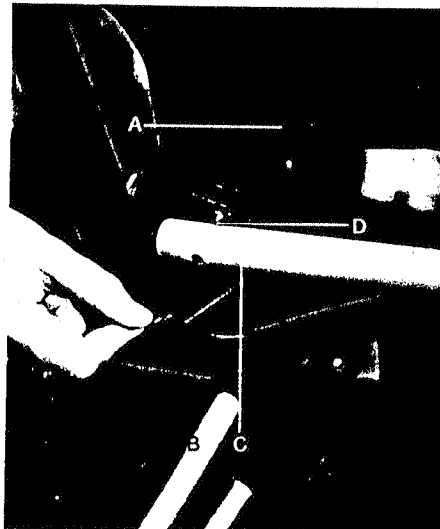

Wedge Latitude Adjuster

(A) Tilt plate (B) Wedge base (C) Latitude adjusting bar (D) Adjusting screw

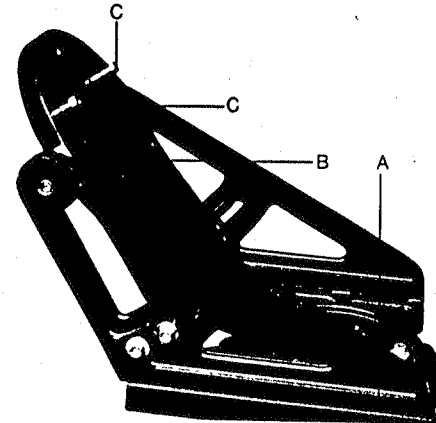

The Equatorial Wedge

(A) Wedge base (B) Tilt plate (C) Mounting pins

#### (3) Attaching the Drive Base

To mount your Celestron to the wedge, align the mounting pins on the wedge tilt plate with the appropriate holes in the drive base and place the base on the wedge. The pins will hold the drive base while you insert and tighten the three 1/2-13x1 1/4" bolts.

Using the provided Allen wrenches, fasten one fork tine at a time to the drive base, using the 3/8-16x1 1/2" bolts provided. On the C14, be sure to place the fork tine with the declination motor on the side of the base that has the electrical connector. Insert the polarized declination motor plug after bolting the fork tines to the base.

#### (4) Installing the Tube Assembly

Rotate the fork tines so that the declination axis is horizontal as shown, and lock the R.A. clamp(s) with the declination saddle arms pointed straight down. The declination clamp on one side and (on the C14 only) the lock screw on the other will hold these in place.

Pick up the tube assembly (pointing straight up) and raise it above the ends of the fork tines and slowly lower it into position. A rugged wooden box about 12" to 16" high may be helpful to stand on while lifting the tube assembly into place. After the mounting pins are seated in the slots of the declination saddle arms, the tube will remain securely in place while you insert the locking bolts through the holes in the saddle arms into the rear cell of the tube assembly and tighten them; do not rotate the fork or tube until these bolts are secure. If the tube does not fit easily between the fork arms, loosen one fork tine at the drive base (not too much!), install the tube and tighten the fork tine.

#### (5) The Finderscope

The standard 10x40 finderscope comes mounted in its bracket. Use the 10-24x3/4" screws provided to mount the bracket onto the rear cell of the tube. The finder was aligned for infinity at the factory, so unless the adjusting screws were disturbed during shipment, the only alignment necessary will be of the finder bracket. With the

mounting screws inserted finger-tight, move the bracket until the object visible in the C11 or C14 is centered on the crosshairs of the finderscope and then tighten the screws.

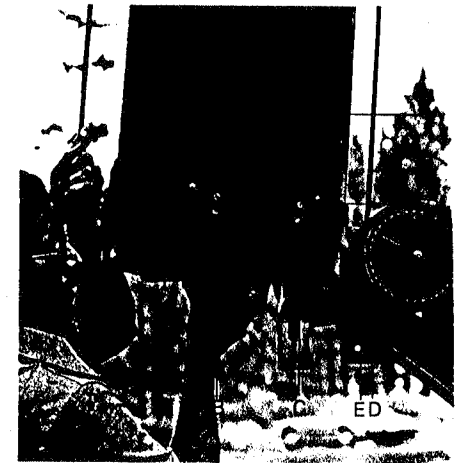

Installing the Tube Assembly

(A) Tube Assembly (B) Mounting pins (C) Slots (D) Declination saddle arms (E) Tube bolt hole

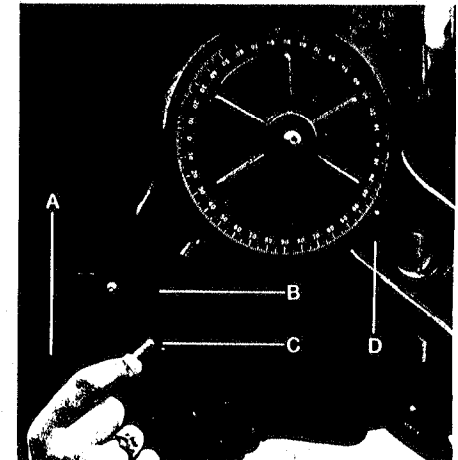

Inserting the Tube Bolts

(A) Rear cell (B) Declination saddle arm (C) Bolt hole (D) Fork line

#### (6) Optional Finderscopes

##### A. 10x70 Finderscope

If you ordered the optional 10x70 giant finder, you will have to insert the finder into the bracket supplied, mount it on the C11/C14, and then align it with the main tube.

Finally, slip the rubber O-ring around the finderscope tube and then insert the tube into the bracket. Position the O-ring so it fits under the front ring in the bracket. Approximately center the scope in the rear bracket ring and thread in the three adjusting screws until they're snug against the finder tube. The finderscope should then be aligned with your main optics for the distance at which you are observing. You align the finder with the three screws on its holder bracket, but before aligning the finder you should check to make sure your telescope has retained its factory-set collimation.

The focus of your finder has been adjusted for infinity with normal eyesight. If your eyesight calls for a different focus, you can change the focus by turning the eyepiece until the view is sharp.

#### B. 8x50 Finderscope

As with the 10x70 finderscope, the finderscope bracket for the 8x50 finderscope must be mounted to the telescope tube. Then the finderscope tube can be added and aligned afterward using the rubber O-ring. The 8x50 finderscope will mount directly on the C11 or C14.

The 8x50 finderscope can be used as a straight-through or as a right angle finderscope. When used as a straight-through finderscope the eyepiece and the long extension tube (included) must be used; remove the extension, place the finderscope eyepiece in the star diagonal, and attach the star diagonal to the rear of the finderscope for use as a right angle finderscope. As with the 10x40 and 10x70 finders, we recommend you remove the 8x50 finderscope prior to placing the optical tube in the case for storage or transportation.

#### C. Extra 10x40 Finderscope

On all the C11's and the latest C14's you may use two finders. The 10x40 Finder and Bracket can be mounted 180° from the standard finderscope. On older C14's you may contact us for instructions on how to attach it.

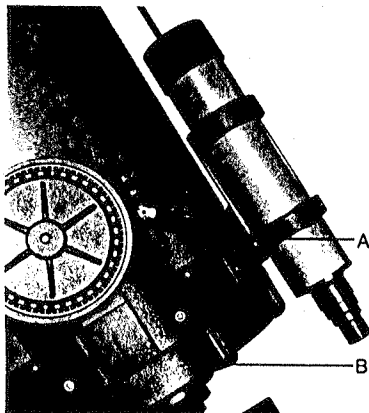

**The Giant (10x70) Finderscope**  
(A) Finderscope bracket (B) Rear cell

#### (7) The Star Diagonal

For the C11, simply thread the 1/4" visual back onto the threads of the reducer plate (after the yellow dust cap has been removed), insert a star diagonal—1/4" into the visual back. Select a low power ocular and place it in the star diagonal; be sure to tighten the thumbscrew to prevent your ocular from falling out.

For the C14, remove the plastic dust cap from the rear of the telescope and unscrew the reducer plate.

Thread the giant star diagonal onto the C14's rear casting.

Now thread the reducer plate onto the diagonal and then thread the 1/4" visual back onto the reducer. Insert an ocular into the visual back and tighten the set screw. Before focusing, unscrew the mirror lock-up screws (which were tightened for shipment). The screws may be left in place, partially threaded in, as hole plugs.

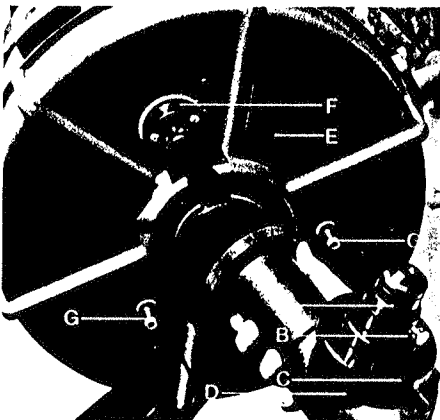

**The C14 Star Diagonal**

(A) 1/4" ocular (B) 1/4" visual back (C) Reducer plate  
(D) C14 Star diagonal (E) C14 rear cell (F) Focus knob  
(G) Mirror lock up screws

## Your First Look

After removing the front lens cover, you're ready for your first look. In selecting an object for observation, try to select one that is fairly bright and easy to find. We'd like your first impression to be a good one.

To raise the tube of your Celestron into viewing position, release the clamp at the top of the fork line.

This clamp is called the "declination (Dec.) slow-motion clamp," for reasons we'll get to later. Raise the tube and relock the clamp.

**DO NOT MOVE THE TELESCOPE TUBE MANUALLY UP OR DOWN WHILE THE DEC. CLAMP IS LOCKED.**

At the base of your Celestron fork lines are one or two clamps. Unlock them, grasp one of the fork lines and swivel the tube in the general direction you'll be looking. Then relock the clamp(s). These clamps are called the "right ascension (R.A.) clamps".

**DO NOT MOVE THE TELESCOPE TUBE MANUALLY SIDEWAYS WHEN THE R.A. CLAMPS ARE LOCKED.**

Once you've selected an object of interest, sight on it through the finderscope. We suggest a bright planet or the moon as a first target. You might have to hunt for the object a little to get into the main field of your telescope, because the finderscope and your main optics may not be perfectly aligned.

The focus control for your Celestron is the black knob located on the rear cell. Turning this knob moves the primary mirror with respect to the secondary mirror and focuses your telescope. Once you've found focus for a particular object, you focus on closer objects by turning the knob clockwise.

A single turn of the focus knob moves the primary a very short distance, thus providing extremely sensitive control of focus. Therefore, it will take a considerable number of turns of the focus knob to travel between near focus and infinity. The range of focus for the Celestron 14 is from approximately 100 feet to infinity and beyond. The C11 has a "near" focus of approximately 100 feet.

Because the Celestron has a large range of focal travel, there might be a tendency for you to get "lost" during focal travel if you are focusing on a dim object. The remedy is to find a brighter object at about the same distance as the desired object, focus on the brighter object, then re-aim the telescope at your object of interest and focus.

In focusing your telescope at high power, you may notice that the image shifts slightly. For the focusing mechanism of the Celestron, an image displacement of about one-third of the field is normal.

#### Hints for the Casual Observer

**NEVER ATTEMPT TO LOOK AT THE SUN THROUGH YOUR CELESTRON OR ITS FINDERSCOPE WITHOUT THE PROPER PROFESSIONALLY MADE SOLAR OBSERVING EQUIPMENT! INSTANT AND PERMANENT EYE DAMAGE MAY BE SUSTAINED—EVEN DURING AN ECLIPSE OF THE SUN.** (See the section on Observing the Sun).

Whenever possible, avoid sighting through mist, fog, haze or heat waves. No telescope can cut through these visual obstructions.

At night, seek out dark, steady skies for celestial observing. Very dark skies are best for nebulae and galaxies, and very steady skies are best for the Moon and the planets. If you find a dim nebula difficult to see, try averting your vision—glancing to the side in your field of view—or moving the field of view back and forth slightly, to bring the more sensitive outer portion of your retina into use.

#### Magnification

To determine the visual magnification of your telescope, divide its focal length by the focal length of the ocular you are using. The effective Cassegrain focal length of the Celestron 14 is 3910mm (154 inches). The Celestron 11 has a 2800mm (110 inch) focal length.

Tabulated in appendix V and VI is the approximate visual magnification of oculars of different focal lengths.

There are upper and lower limits of magnification for your telescope. These limits are determined by the laws of optics and the nature of the human eye.

The upper limit of magnification (which may be achieved only when the air is very steady) is about 60x per inch of aperture, or about 840x with the C14, or 620x with the C11. The lower limit of magnification is about 4x per inch of aperture; about 44x with the C11, and about 56x on the C14.

#### MULTIPLE OCULAR HOLDER

For use with 1/4" oculars this device allows you to attach as many as four oculars to your instrument at once and rotate the desired ocular into use.



*Multiple Ocular Holder (1/4" version on C14)*

#### The Optional Barlow Lens (2x and 3x available)

The range of magnification of any given set of oculars may be increased with the use of a Barlow lens. The Celestron 1/4" Barlows will double or triple the power of any of our oculars and also comfortably increases the eye-relief distance. However, there is some sacrifice of image quality. This accessory inserts into the visual back and accepts 1/4" oculars. A 2" Barlow lens is available for use with 2" oculars and is 2x.

#### The Most Useful Powers

The utility of any given magnification will depend upon your subject's apparent size, its apparent brightness and the seeing conditions. High powers tend to decrease image brightness, diminish the field of view and magnify air turbulence.

Planets, lunar craters, some of the globular clusters and planetary and diffuse nebulae will be very pleasing objects through C11's and C14's between 100x and 220x.

For observing the Moon and planets in greater detail, you'll have to go to higher power. Here, magnifications between 220x and 435x will be very useful.

Extremely high magnification oculars can be profitably used on objects of suitable brightness and during nights of extremely fine "seeing". Lunar and planetary detail, and close double stars are suitable subjects; but to avoid disappointment, be sure first that the atmosphere is stable enough for such magnifications. Pronounced star "twinkling" indicates turbulence overhead, producing a telescopic image "shimmer" similar to the effect of viewing a daytime, naked-eye object over heated pavement. On such nights, high power will simply magnify the effects of turbulence, while lower powers may show a steadier and more satisfactory image.

#### The RFA (Rich Field Adapter)

The Celestron RFA utilizes a high quality, positive achromatic lens to compress the light cone exiting from

the rear cell of a Celestron. The RFA will alter the optical properties of a Celestron telescope so that the  $f/r$  ratio is one-half the normal Celestron  $f/r$  ratio;  $f/5$  for the C11 and  $f/5.5$  for the C14. This doubles the field-of-view for a given ocular and increases the brightness by a factor of 4.

The RFA is made up of several components whose specifications and dimensions are critical. A special custom T-adapter is used, to mount the device on the back of a Celestron, a Tele-Compressor lens is threaded on the T-adapter, then a custom threaded ring is attached to the Tele-Compressor lens and finally the 20mm Erfle ocular is inserted in the diagonal (which is threaded onto the custom threaded ring).

Optimum performance on most objects will come from using the wide-field 20mm Erfle ocular supplied with the RFA. The RFA is also fully compatible with the Celestron LPR Filter. The LPR Filter and RFA make a spectacular combination for deep-sky observing under less than ideal conditions.

You may use any  $1\frac{1}{4}$ " O.D. ocular in the RFA; however, many long focal length oculars supplied by other manufacturers may exhibit some vignetting. The RFA will double the field-of-view of any Celestron  $1\frac{1}{4}$ " O.D. ocular (except the 40mm and 32mm) without any vignetting. You may notice some aberration near the edge-of-the-field when using the RFA. This is normal and much less objectionable than the coma inherent in many short-focus reflecting telescopes. Note: Some short focal length (less than approx. 12mm) oculars may not be useable with the RFA.

To use the RFA simply thread the RFA directly onto the reducing plate on the rear cell of the C11 or C14, aim and focus. The RFA will give a wider field, but not as bright (low power), as the 2" oculars. The 2" oculars, below, give the best image quality.

#### The 2" O.D. Oculars

If your tastes run primarily to deep-sky observing, the optional Celestron 2" O.D. oculars provide spectacular, low-power, wide-field views of large galaxies and diffuse nebulæ.

The 70mm, 60mm, 50mm, and 40mm oculars provide the greatest true field and apparent subject brilliance, but they require dark, clear skies and an absence of local artificial lighting, so that your eyes can achieve full "dark-adaptation". The 32mm Erfle, on the other hand, provides adequate subject brightness for rewarding deep-sky work, is quite usable under less-than-perfect skies, and affords a gigantic apparent field-of-view besides—much like looking through a gigantic porthole into space! For magnifications see appendices V and VI. The 18mm and 25mm are best used for planetary and smaller deep-sky objects.

To use the 2" O.D. oculars on the C14, remove the  $1\frac{1}{4}$ " visual back and reducer plate from the diagonal and thread on the 2" ocular adapter. After inserting the 2" ocular, tighten the set screw to hold the ocular in place.

On the C11 you remove the  $1\frac{1}{4}$ " ocular, Star diagonal, and visual back and replace these with the 2" diagonal-5/8/11. Insert a 2" ocular and tighten the set screws.

#### The Electric Clock Drive

Installed in the base of your Celestron is a precision motor drive system. This system acts as a 24-hour clock that keeps time with the stars. It rotates your R.A. setting circle westward at the same rate that the stars appear to move. It also rotates your fork mount when the R.A. clamps are engaged.

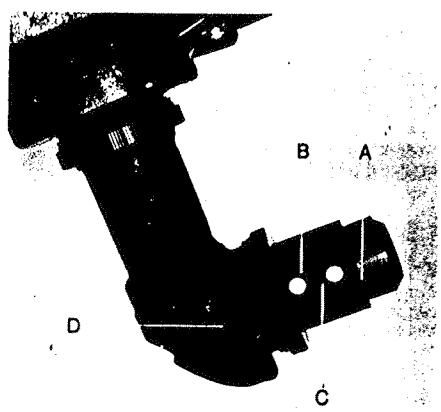

#### Two Inch O.D. Oculars on the C14

(A) 2" O.D. ocular (B) 2" I.D. adapter (C) Set screws (D) Star diagonal

After you've lined up on the pole (See pages 9–11) just plug the clock drive into an electrical outlet (using the cord supplied with your telescope) and any deep-space object you dial into view will stay there.

Unless you specified otherwise, your Celestron is designed to operate on 120 volt 60 Hz electrical current. Note that by using a Celestron DC inverter or drive corrector you can operate the telescope clock drive off a 12-volt battery.

Extending down from each R.A. clamp is a screw. When the clamps are engaged, the screws push a pressure plate attached to the fork mount down onto the R.A. gear. This "locks" the fork mount to the drive system so that if the clock drive is running, the fork mount turns and the telescope tracks.

The pressure plate is very responsive to the action of the R.A. clamps. Adjust the drag to fit the occasion: full when your scope is carrying instrumentation... moderate when using the telescope with no accessories attached... and zero when swiveling the fork manually.

**DO NOT FORCE THE FORK MOUNT TO SWIVEL WHEN THE R.A. CLAMPS ARE ENGAGED. THIS WILL CAUSE PRESSURE PLATE WEAR.**

#### The C14 Electric Slow-Motion Controls

Plug the hand control box into the drive base and you can use the electrical slow-motion controls to center objects in the field of view or to correct for any drift due to minor polar misalignment. One of the toggle switches controls movement in right ascension; the other, declination.

When the slow-motion switch on the drive base is in the left position, the hand control provides a fast slewing rate. When the switch is positioned to the right, a slower rate results.

The C11 has an optional electric declination guide/slew motor (see page 20).

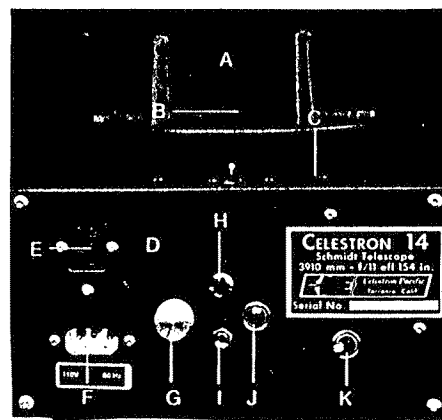

#### The C14 Drive Control Panel

(A) Fork tines (B) R.A. clamp (C) R.A. setting circle (D) Drive base (E) Hand control box receptacle (F) Power cord receptacle (G) Illuminator light brightness control (H) Pilot light (I) Illuminator light jack (J) Power on-off switch (K) Slow-motion rate switch

#### Setting Your Dec. Setting Circles

The declination setting circles of your Celestron should be aligned so that the  $90^\circ$ - $90^\circ$  line on each parallels the optical axis of your telescope. When the optical axis of your telescope is parallel to the polar axis of your telescope, the Dec. pointer on the fork tine at the bottom of the Dec. circle should give a reading of  $90^\circ$  (make this adjustment, approximately, before proceeding).

To set the circles accurately, first orient your telescope tube with the finderscope up. Then center an object such as a star or a planet in the field of your main optics. Note the Dec. reading on one of the circles. Now tumble the telescope tube in both R.A. and Dec. until the finder is under the tube and you have the same star centered in the field again. Note the Dec. reading (on the same circle). It should be the same as before. If the reading is not the same, you'll have to rotate the circle back to its proper position. The correct position will be such that they coordinate exactly halfway between your first and second readings is opposite the Dec. pointer. For the greatest accuracy, repeat this procedure until the identical reading is obtained after the tube is tumbled. This will also be the correct reading for your other Dec. circle.

The Dec. circle is held in position by a circular retainer plate, which is held in place by a small Allen screw at its center. Loosen the screw before trying to rotate the circle, and after setting the circle, tighten the screw so the circle can't rotate.

#### The Celestial-Coordinate System; R.A. Setting Circles

The celestial-coordinate system is an imaginary projection of the Earth's geographical coordinate system onto the starry sphere which seems to turn overhead at night. This celestial grid is complete with equator, latitudes, longitudes and poles, and it remains fixed with respect to the stars.

(Actually, the celestial-coordinate system is being displaced very slowly with respect to the stars, because the Earth's axis is very slowly changing the direction of its point. This effect is slight, however, and in any case it is being continually accounted for as new star atlases are published.)

The celestial equator is a full  $360^\circ$  circle bisecting the celestial sphere into the Northern Celestial Hemisphere and the Southern Celestial Hemisphere. Like the Earth's equator, it is the prime parallel of latitude and is designated  $0^\circ$ . The celestial equator passes through the constellations Orion, Aquila, Virgo and Hydra.

The celestial parallels of latitude are called "coordinates of declination (Dec.)," and like the Earth's latitudes they are named for their angular distance from the equator. These distances are measured in degrees, minutes and seconds of arc. Declinations north of the celestial equator are "+", and declinations south are "-". The poles are at  $90^\circ$ .

The celestial parallels of longitude are called "coordinates of right ascension (R.A.)," and like the Earth's longitudes they extend from pole to pole. There are 24 major R.A. coordinates, evenly spaced around the equator, one every  $15^\circ$ .

Like the Earth's longitudes, R.A. coordinates are a measure of time as well as angular distance. We speak for example, of the Earth's major longitudes as being separated by  $15^\circ$ , but we can also say they are separated by one hour of time because the Earth rotates once every 24 hours. The same principle applies to celestial longitudes since the celestial sphere appears to rotate once every 24 hours.

Astronomers prefer the time designation for R.A. coordinates even though the coordinates denote locations on the celestial sphere, because this makes it easier to tell how long it will be before a particular star will cross a particular north-south line in the sky.

So, R.A. coordinates are marked off in units of time eastward from an arbitrary point in the constellation Pices. The prime R.A. coordinate which passes through this point is designated "0 hours 0 minutes 0 seconds." All other coordinates are named for the number of hours, minutes and seconds that they lag behind this coordinate after it passes overhead moving westward.

Given the celestial-coordinate system, it now becomes possible to find celestial objects by translating their celestial coordinates into telescope point. For this, your Celestron comes equipped with setting circles. The dial at the base of your telescope is the setting circle for R.A. The dials at the top of the fork tines are your setting circles for Dec. You can use these circles to acquire celestial objects once you have properly mounted your Celestron on its equatorial wedge (or pier) and pointed the polar axis of your telescope toward the North Celestial Pole.

#### Lining Up on the Pole

The celestial pole is that imaginary point on the celestial sphere toward which the Earth's axis of rotation points. It is around this point that the stars appear to move nightly—their paths being concentric circles with the celestial pole at the center. If the polar axis of your telescope points directly at the celestial pole, then a star at any declination may be kept centered in the field of your telescope simply by rotating the telescope in right ascension, or by letting the electric clock drive of your telescope rotate for you in right ascension.

For casual visual observing, a simple polar alignment on the north star, Polaris, is adequate. Polaris, which is within 1° of the true north celestial pole, is easy to find. The pointer stars in the bowl of the Big Dipper point straight to Polaris (see the diagram of the Celestial Polar Region).

Tilt the telescope tube until the declination circle reads 90°, then move the tripod and adjust the wedge until Polaris is in the center of the field of view. (Refer to the section on "The Equatorial Wedge" to find the procedure for making fine adjustments to the wedge). The telescope is now ready to be used. The circles will read to within approximately one-degree accuracy and the drive will keep an object in the field of view for a considerable period of time.

To achieve a more accurate polar alignment after aligning on Polaris, repoint the telescope at a bright star near the celestial equator. Look up that star's right ascension in a star atlas and move the R.A. setting circle until the R.A. pointer is indicating that right ascension. Now turn the telescope in R.A. until it indicates the R.A. of Polaris (this is currently 2 hr. 10 min.) and lock the R.A. clamps. Now move the telescope tube only in declination until the declination pointer indicates 90°. From this point, continue moving the tube in the direction away from the Big Dipper (i.e. toward Cassiopeia) until the declination reads +89.2° (the declination of Polaris). Lock the declination clamp. Now move the tripod and adjust the wedge until Polaris is centered in the field of view.

The telescope will now be aligned well enough for you to try deep sky photography using exposure times of up to 15 minutes or so without significant mistracking.

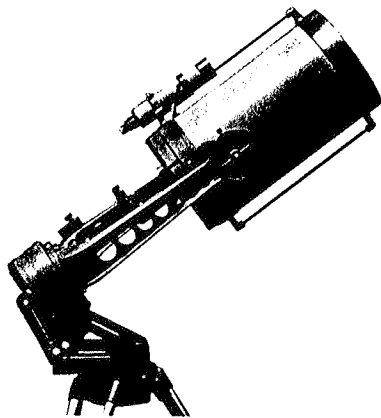

Pointing at Polaris

The C14 optical axis is parallel to the polar axis (declination pointer reads 90°).

#### Precise Polar Alignment for Astrophotography

There are several advantages in precisely aligning your telescope to the true north celestial pole. With an exact polar alignment, there will be no image drift in declination, the tracking will be more accurate, and your setting circles will read very accurately. Because it eliminates the need to make corrections in declination during long

exposure astrophotography, it allows you to concentrate on R.A. corrections.

After the quick alignment methods described previously, you will need an illuminated reticle eyepiece for this more precise method. A Barlow lens will also speed the procedure considerably.

Insert the illuminated reticle (and Barlow if used) and repoint the telescope at a fairly bright star near where the meridian and the celestial equator intersect (preferably within  $\pm \frac{1}{2}$  hour. R.A. of the meridian and  $\pm 5^\circ$  of the celestial equator) and monitor the declination drift (ignore any drift in R.A.)

a. If the star drifts south, the polar axis points too far east.

b. If the star drifts north, the polar axis points too far west.

Move the telescope's polar axis in the appropriate direction until the north or south drift stops. Accuracy of this adjustment will be increased if you use the highest possible magnification and allow the telescope to track for a period of time.

Now repoint the telescope at a fairly bright star near the eastern horizon and near the celestial equator (the star should be at least 20° above the horizon and  $\pm 5^\circ$  from the celestial equator).

a. If the star drifts south, the polar axis points too low.

b. If the star drifts north, the polar axis points too high.

Again, monitor only the declination drift using high magnification over a period of time. After you have made the necessary adjustments to stop the declination drift, you will have achieved a highly accurate polar alignment.

This same procedure may also be employed by Southern Hemisphere observers, but the directions of drift are reversed.

#### Using Your Setting Circles

Note: R.A. circle calibration will change when the C14 slewing controls are used.

The right ascension (R.A.) setting circle is located near the top of the drive base of your telescope. Every one of the 24 hours of R.A. is divided into 12 intervals of 5 minutes each.

A declination (Dec.) setting circle is located near the top of each fork tine. Each graduation on the Dec. circles represents one degree.

Declination readings between your +90° pole setting and the 0°-0° equator line are "+" and readings on the other side of the 0-0 line are "-".

Once you've lined up on the pole and set your R.A. setting circle, you'll be able to use the setting circle readings to translate the star atlas coordinates of a celestial object into telescope point. To set the R.A. setting circle, center a star of known R.A. in the field of your telescope (see the alphabetical star listing at the back of this manual), then rotate the circle (it will turn freely) until the coordinate of the star is under one of the two R.A. pointers located at the base of the fork mount.

Use whichever R.A. pointer is most convenient to see. Remember after setting the R.A. with one pointer that the other pointer will read 12 hours off. If you switch from one R.A. pointer to the other, you will have to allow for this (or reset the circle using the other pointer).

Now that the R.A. circle is set, use a star atlas to look up the coordinates of the object you wish to observe. Rotate the fork mounting until the R.A. of the object you selected is indicated and lock the R.A. clamps.

Next, move the telescope tube in declination until the proper declination is indicated and lock the clamp.

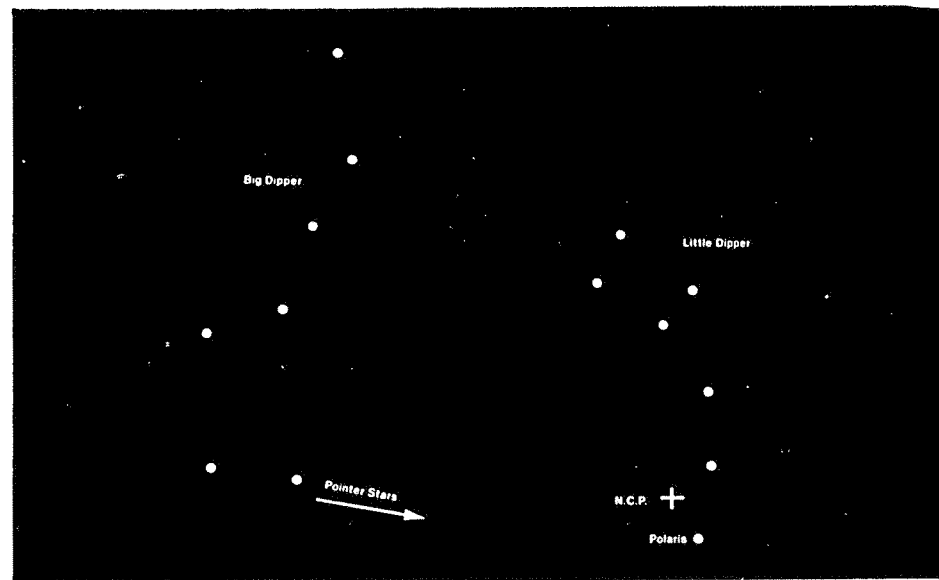

#### The Celestial Polar Region

The two stars in the front of the bowl of the Big Dipper point right to Polaris. Polaris is less than 1° from the true North Celestial Pole (N.C.P.). See "Lining Up on the Pole". Consult a star chart or astronomy field guide (several suggested in Appendix VII) for more help in locating the Pole Star.

Use your lowest power eyepiece when trying to locate a celestial object. Bear in mind that your Celestron is such a powerful (long focal length) telescope that the field of view is limited, so you might have to "sweep" a little in both R.A. and Dec. to bring the object into view. The electrical slow-motion controls of a C14 are ideal for this purpose or the dual-axis drive corrector for the C11.

If you don't find the object quickly, check your finder-scope. Most objects will be visible through it and you'll be able to quickly center the object. If your finder is accurately aligned, the object will then be in the field of the main telescope.

After you've observed your object for a while and decide to seek out another object, just release the clamps and move the telescope until the proper coordinates are indicated. As long as you use your Celestron with the clock drive operating, your R.A. circle will read correctly.

If electrical power is not available, you can still use the setting circles. Just before seeking out your next object, re-set your R.A. circle to the R.A. of the object you've been observing. Then use your circles in the normal way, re-pointing as quickly as possible. The clock drive and circles will function with the use of a Celestron drive corrector or D.C. inverter to power the unit from a 12-volt battery.

#### Using Your Celestron/Temperature Differences

You now own a portable, large-aperture, high performance telescope of extreme versatility and usability.

To obtain the best performance from this or any other telescope, you must allow sufficient time for the instrument to adjust to the prevailing outdoor temperature. If the outdoor temperature is very low and the instrument has been stored in a heated building, the "cooling-off"

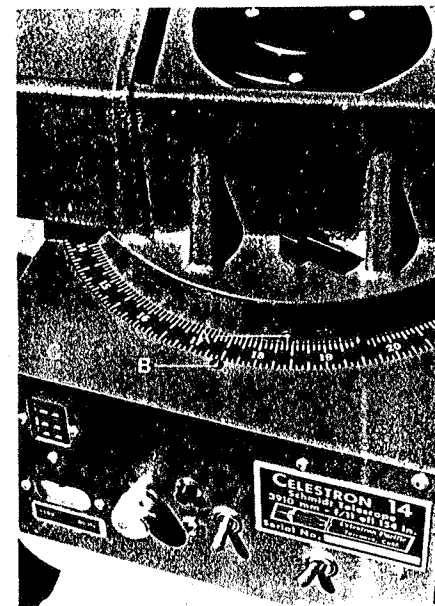

#### The C14 R.A. Setting Circle

(A) The R.A. pointer, which is indicating 18 hours, 25 minutes (B) Meridian indicator (C14 only) (C) Drive base.

The C14 comes with two bars and the C11 has one with an extra bar and weights available as an accessory if desired.



**Using the Counterweights**  
(A) Counterweight (B) Allen wrench (C) Counterweight bracket (D) Counterweight bar.

#### Observing With Your Celestron

**CELESTIAL OBSERVING IS A LEARNED SKILL—THE MORE OBSERVING EXPERIENCE YOU ACQUIRE, THE MORE DETAIL YOU'LL SEE. TAKE YOUR TIME WHEN OBSERVING. LOOK FOR A PERIOD OF TIME RATHER THAN JUST TAKING A QUICK GLANCE AT THE OBJECT.**

As stated earlier, high power observing of the Moon, planets, or close double stars requires steady, stable atmospheric conditions. When observing the Moon or planets, you'll quickly note (by the amount of detail you see) that the seeing conditions vary considerably with time. During periods of good seeing, the incredibly detailed views through your Celestron telescope will amply reward your patience.

"Seeing" is termed good when atmospheric turbulence is at a minimum. You can determine this with the naked eye by observing how much the stars appear to twinkle. When the stars shine with a steady glow (rather than twinkle) the seeing is steady.

Deep sky observing (of nebulae and galaxies) is not nearly as affected by seeing conditions as lunar and planetary viewing. Here the most important factors are the transparency of the atmosphere and the darkness of your observing site. While the tremendous light-gathering ability of the C11 or C14 will disclose detail in deep sky objects when the telescope is used in urban locations, we can't over-emphasize the advantage of observing such objects from a dark-sky location. From a dark-sky site, you'll see the faint, filamentary details usually seen only in observatory photographs.

Here are a few excellent first subjects to begin your observing program:

#### The Moon

The Moon is best viewed during its partial phases and at its highest point in the sky. At low power, broad areas along the terminator will be extremely sharp and detailed. At high power, you'll be able to watch the terminator

gradually advance—towering peaks will blaze in sunlight while their lower surroundings are still lost in lunar predawn shadow.

Tiny craterlets can be seen peppering the floors of large craters and walled plains like Plato and Clavius. About 2 days past First Quarter, you'll be able to study the intricate terracing of the walls of the crater Copernicus. A winding chain of tiny craters will be easily visible just northwest of this crater.

If you find that the lunar image is too bright for comfortable viewing, a yellow filter or a neutral density filter, or the Polarizing Filter Set will help reduce the glare (see the section on eyepiece thread-in filters).

#### The Planets

Because the planets move with respect to the stellar background, their positions are always changing. Refer to the astronomical magazines listed at the back of this manual for their current locations.

**MARS**—Detailed views of Mars are only possible when the planet is near opposition. For Mars, these oppositions occur every two years and fifty days, on the average.

Mars, like other planets, is best viewed when highest overhead and at moderate magnification. Best views are obtained when Mars has its closest approach to Earth.

Of all the planets, Mars is the only one with permanent, recognizable surface details. You'll be able to watch enormous, raging dust storms perceptibly change the shape of these surface details from the easily identifiable features shown on Martian maps into a variety of interesting, new forms.

Orange or red filters reduce glare and help increase the contrast of Martian surface features. A blue filter is useful for emphasizing the atmospheric features of Mars (see the section on eyepiece thread-in filters).

**JUPITER**—During many months of each year, Jupiter is easily visible. Through the Celestron, the cloud belts of Jupiter are delicately festooned and display a range of color—from cream through orange to grey—and within the belts are numerous smaller storms (white spots).

A blue filter helps to increase the contrast of the cloud belts and the Great Red Spot as well as reduce glare. With a steady atmosphere, detail can even be glimpsed, with the C14, within the Red Spot and on the largest Jovian moon, Ganymede. Note that the Red Spot of Jupiter has faded since 1975, so that it is somewhat difficult to see visually.

**SATURN**—Like Jupiter, Saturn is visible for many months each year. With the Celestron, the major divisions of Saturn's ring system are instantly obvious, and your attention is drawn to the surface detail of the planet itself. There is a striking amount of banded detail on the globe—usually including one or more white spots—and there is a hint of belt structure near the polar region. You'll notice, too, that Saturn's moon Titan appears as a disk under very steady seeing.

#### Star Clusters

Star clusters fall into the two general categories: open star clusters (sometimes called Galactic Clusters) and globular star clusters.

Open clusters are loosely arranged groups of stars, often not too distinctive from the background stars. Since they are relatively large groupings, they are best seen through low-power, wide-field oculars such as the 2" oculars or the RFA, from the dark-sky locations.

M35 is an excellent example of an open cluster, visible during winter months in the constellation Gemini. You'll see a swarm of glittering stars that fill a low-

power field-of-view. The C14 will easily resolve the tiny companion cluster (NGC 2158) near the southwest edge of M35.

M11 is a magnificent galactic cluster visible during the summer in the constellation Scutum. A noted observer once described M11 as resembling a "flock of wild geese"—a striking view.

Globular star clusters are tightly-packed, spherically shaped groups of many thousand stars. Moderate to high-power will show these objects to best advantage.

M13 in Hercules is generally regarded as the finest globular cluster in the northern sky. The C14 will resolve stars down to the core and reveal dark lines and streamers of stars radiating outward. The C11 will also have high resolution but it will not show stars as faint as those seen with the C14.

M15 is a bright but smaller autumn-sky globular cluster in the constellation Pegasus. It contains over 60 variable stars. With the great light grasp of a Celestron, stars are resolved nearly to the center.

#### Nebulae

Nebulae, or glowing clouds of gas, fall into the two distinct categories: small, bright, planetary nebulae and the large, bright, diffuse (or emission) nebulae.

The word "bright" sometimes gives an exaggerated notion of the amount of light given off by these nebulae (and galaxies). The published magnitudes of nebulae and galaxies are the magnitudes these objects would have if their images were compressed into the size of a single stellar image, so don't expect a third magnitude nebulae to appear as bright as a third magnitude star.

Planetary nebulae are relatively small clouds of expanding gases and are believed to be the remnants of stellar explosions. Most shine with a greenish glow and have a round or elliptical shape.

Planetary nebulae are best seen when using moderate to high magnification from dark-sky locations. To see some of the really faint details, try averting your vision. Averted vision is glancing off to the side of the field-of-view instead of looking directly at the object of interest.

The Ring Nebula (M57) is one of the loveliest planetary nebulae. Resembling a nearly perfect smoke ring, the various contrast levels of the nebulosity itself are evident.

Look closely for the dull illumination in the center of the ring. The extremely faint central star may be occasionally glimpsed through the C14. The Ring Nebula is visible during the summer months in the constellation Lyra.

The Dumbell Nebula (M27) closely resembles its black and white photos with scores of stars apparently imbedded in its oval—a marvelous sight through a Celestron. The Dumbell is a summer object visible in the constellation Vulpecula.

Diffuse or emission nebulae are vast, irregularly shaped clouds of rarefied gas. They are called "bright" because they are spurred into luminescence by radiation from nearby stars or because they reflect the light of nearby stars.

These large, dim objects are best seen using low-power, wide-field oculars. The optional Celestron 2" O.D. wide-field oculars or RFA are ideal for this purpose. Observe these objects from a dark site and use averted vision to see the really faint details. Near a city, use a Celestron LPR filter (p. 15).

The Great Nebula in the winter constellation Orion (M42) is one of the most magnificent objects in the sky.

It will fill a low-power field-of-view with its intricate, filamentary network, which is itself laced with many knotty brightenings. The dark clouds of the nebulae are crisply defined.

The Lagoon Nebula (M8) is one of the largest, star-studded wonders in the summer Milky Way. Its swirling nebulosity is divided nearly in half by a huge, dark lane. An open star cluster, NGC 6530, is imbedded in the nebula.

Slightly north of the Lagoon is the Trifid Nebula (M20). Both components are well detailed, with the brighter part clearly trisected by dark lines. Both the Trifid and Lagoon nebulae are located in the constellation Sagittarius.

#### Galaxies

Galaxies are vast, remote "island universes", each composed of many millions of stars. They exist in a variety of sizes and regular and irregular shapes, and most are faint, therefore, they are best seen from a dark-sky location. Large galaxies (or clusters of galaxies) are best seen when using low-power, wide-field oculars. Small galaxies are better seen when using moderate magnification.

The Andromeda Galaxy (M31) is the largest, brightest spiral visible in the night sky. Its core is ablaze with the light of a million suns. You'll easily see the dark lanes separating the faint, outer spiral arms as well as emission nebulae within the arms from a dark-sky location.

The magnificent Whirlpool Galaxy (M51) in the constellation Canes Venatici, is best seen in Spring when it's at its highest point in the sky. The spiral arm connecting the Whirlpool to its companion galaxy is quite distinct.

A copy of the Messier Catalog of non-stellar objects is included at the back of this manual.

#### Observing the Sun

Our Sun, the nearest star, is a truly exciting celestial object. Its boiling, granulated surface occasionally displays the magnetic storms we know as sunspots. Against the background of its disc, Mercury and Venus sometimes pass in transit, as does the Moon during a solar eclipse.

**BUT WE REPEAT: NEVER LOOK AT THE SUN THROUGH YOUR CELESTRON OR ITS FINDERSCOPE WITHOUT HAVING EQUIPPED YOUR INSTRUMENT WITH THE PROPER PROFESSIONALLY MADE SOLAR FILTER SYSTEM! INSTANT AND IRREVERSIBLE EYE DAMAGE MAY RESULT—EVEN DURING AN ECLIPSE OF THE SUN.**

The safest type of solar filter is the glass-window type that slips over the front cell of your telescope. This type is available from Celestron as an off-axis filter (5" for the C11, 8" for the C14) that reduces the intensity of the solar radiation at all wavelengths.

The Celestron solar filter permits extended observation of the Sun in complete safety and comfort. When observing with this accessory, however, be certain to take the following precautions: 1. Be sure to place the filter snugly over the front cell of your telescope. 2. Do not leave your scope unattended during an observing session, and 3. Always cap the finderscope so the heat from the Sun's rays doesn't damage the delicate cross hairs.

Other filters may be used with the Celestron filter to reduce the brightness of the solar image even further. A neutral density filter, which can be threaded into the side of the ocular, is included in our thread-in filter set. By themselves, these filters give insufficient protection for solar observation!

Do not view the solar disc by projecting its image through your Celestron onto a white card. **WE DON'T RECOMMEND IT BECAUSE THE PROJECTED IMAGE IS INFERIOR AND BECAUSE THE RESULTANT HEAT BUILDUP IN YOUR SCOPE MAY DAMAGE YOUR SECONDARY MIRROR AND EYEPIECE IF THE PROJECTION TIME EXCEEDS A FEW SECONDS.**

We caution against the use of Herschel prisms, sun diagonals, eyepiece solar filters and the like. The elements of these accessories have been known to separate or fracture as the intense solar radiation builds up at their location in an optical system, and internal damage to the Celestron can occur.

#### Eyepiece Thread-in Filters\*

These filters, available in three sizes for the 2", 1 1/4", or .96" diameter eyepieces, will significantly improve your views of many celestial objects. Their main purposes are to decrease glare and improve contrast. All have sufficient blocking density to reduce glare and subject brightness, but the #96 Neutral Density is to be preferred for this purpose, because it leaves colors unaltered. To increase subject contrast, choose the filter which comes closest to being the complement of subject color you wish to observe—e.g., a yellow filter will always help cut through bluish sky haze. Some specific suggestions follow, but you may wish to experiment further on your own: \*Note with Celestron oculars you do not need the filter adapter for use with Celestron eyepiece filter sets.

#3N5 Yellow—Mainly a filter for lunar work. Especially useful for improving contrast and reducing irradiation between features of varying brilliance. Also valuable for penetrating the atmospheres of Jupiter, Saturn or Mars since it reduces scattered blue light.

#21 Orange—Does what the yellow filter does, only more so. Brings out structure in Jupiter's belts and Saturn's bands, allows intermediate probing of Martian atmosphere, and increases contrast between Martian maria and deserts.

#47 Violet—For studies of Venus in particular. Increases contrast of upper atmospheric clouds. Also useful in detecting clouds over Martian polar caps.

#58 Green—Excellent for increasing contrast of the Martian polar caps, low-flying Martian clouds and yellowish Martian dust storms. Good, too, for studies of low-contrast, blue and red Jovian features, and for studies of Venus and the Moon.

#80A Blue—Primarily for studying structures of planetary features in upper atmospheres, such as the features of Jupiter's Great Red Spot or the festoons in Jupiter's belts. Also useful as a moon filter under dark skies.

#96 Neutral Density—A moon filter in the usual sense. Decreases glare of full or gibbous moon by uniformly reducing light transmitted over the entire spectrum. Also improved resolution of double stars of widely different magnitudes.

#### Filter Adapters/Adapter Bushings

Two filter adapters are available for using Celestron eyepiece filters and LPR filters with eyepieces normally used on the C11 and C14. Note that these filter adapters are not necessary if you are using Celestron oculars and Celestron eyepiece filters, *unless* you want to have the ability to change oculars very rapidly without having to thread a filter into each ocular individually.

The Filter Adapter—1 1/4" allows the attachment of filters from the Celestron Eyepiece Filter Set 1 1/4" and the #4 LPR Filter to those 1 1/4" oculars made by other manufacturers which do not have internal threads compatible with our filters. The ocular is quickly but firmly attached to the adapter via a thumbscrew. Thus, you can use any given filter on different oculars with very rapid changeover (Celestron 1 1/4" oculars can also be used in this same way). In cold climates you can use this adapter for using a selected filter with various eyepieces without removing your gloves to change the filter.

The Filter Adapter—2" incorporates the same advantages as the filter adapter 1 1/4" for oculars of 2" diameter except that no thumbscrew is used to secure the filter adapter to the 2" ocular. You'll be able to use the Celestron eyepiece filter set 2" and the Celestron LPR filter model #5 with virtually any 2" diameter ocular. This adapter is meant to slide into the Celestron 2" diagonal; the 2" ocular then slides into the 2" visual back to hold the adapter/filter in place.

The expanding bushing—.96" to 1 1/4" allows you to use .96" oculars with the normal 1 1/4" visual back on the C11 or C14.

#### LPR (Light Pollution Rejection) Filter

Makes bright, light-polluted skies appear darker by rejecting radiation from mercury and sodium lights. Allows maximum transmission of the important wave lengths of Hydrogen Alpha, Hydrogen Beta, Doubly Ionized Oxygen, and Singly Ionized Nitrogen. Thus you can enjoy emission nebulae (galaxies and star clusters with associated nebulosity) from urban locations. Models #3, #4, and #5 thread into oculars like the eyepiece filter set; for .96", 1 1/4" and 2" oculars respectively. Model #1 threads on the back of the C11/C14 reducer plate and accepts all visual and photographic accessories. Model #2 threads directly onto the C11/C14 rear cell and accepts the C14 giant diagonal or the C11/C14 reducer plate. Model #7 is for the deep sky astrophotographer; it mounts between the off-axis guiding system and your camera for taking long exposure, deep sky photographs. When using the LPR filter for astrophotography you will have to increase your exposure time by a factor of two or three to record stellar objects to the same density as without the LPR filter. Emission nebulae will be recorded to the same density on your film in approximately the same time with or without the LPR filter. LPR models #1, 2, 7 are intended for both photographic and visual use.

Due to the spectral response of a typical Celestron LPR filter, the light from an emission nebulae that is transmitted through to your film (or eye when used in a visual mode) is largely unchanged in its quality (spectrum). This means that color photography will yield an image of nearly natural color balance. Your choice of film and its reciprocity characteristics may alter the color balance more than the LPR filter. Other apparent color changes can be caused by the lack of artificial radiation, background continuum, and minor nebular emissions that are filtered out by the LPR filter. Consult our general catalog for technical specifications and spectral responses of the various LPR models.

#### Polarizing Filters

Celestron offers two types of polarizing filters. Polarizing filters can be used for improved views of bright objects (moon, planets), as a variable neutral density filter and to observe polarization effects. One type, the

Eyepiece Polarizing Filter Set is available in .96", 1 1/4" and 2" sizes for the respective series of eyepieces. A Photographic Polarizing Filter Set is also available for prime focus/telephoto photography.

When using the Eyepiece Polarizing Filter Set (EPFS), one polarizing filter threads into the appropriately sized eyepiece and one threads into the appropriately sized eyepiece filter adapter. When both filters are in place you can rotate the ocular and change the orientation of the Polaroid material; this will allow you to use the Polaroid filters as a variable density neutral density filter. Using only one filter and rotating it (either rotate the eyepiece or the filter adapter; whichever has the filter), you can observe polarization in objects or increase image contrast with the polarized filter. When you purchase the set, the correct filter adapter is supplied.

The Polarizing Filter Assembly allows photography at prime focus with one or two polarizing filters. Your camera's T-ring (see below) will thread on the back of the Polarizing Filter Assembly; should you wish to use only one filter the stationary filter can be removed by taking off the camera T-ring and unthreading the stationary filter and its cell from the remaining portion of the polarizing filter set. The camera T-ring will then thread directly back on the polarizing filter set without the stationary filter and the one variable position filter can be used for the standard special effects a polarizing filter is capable of.

#### Photography With Your Celestron

Most 35mm single-lens reflex cameras with removable lenses and focal plane shutters can be coupled to the telescope with Celestron camera adapters. (Larger format cameras may be coupled with special adapters you'll have to get custom-made at a local machine shop.)

The standard Celestron camera adapters convert your scope to the universal "T" adapter system used by photographers. With this system, the "T" adapter threads onto the 3"-2" reducer plate, which is threaded directly onto the rear cell of the Celestron. The "T" camera ring couples your camera (minus lens) to the "T" adapter. The "T" adapter places the film plane of your camera at Cassegrain focus and its slip-ring lets you orient your camera body as desired.

During the day, coupling your camera to the C14 in this manner gives you the world's longest focal length telephoto lens—a 3910mm (80x) f/11!

Since the Celestron has a fixed aperture, you'll have to adjust the shutter speed to the proper exposure time for an f/11 lens. (f/10 for the C11; a 2800mm telephoto)

Most 35mm SLR cameras with behind-the-lens metering systems have special procedures for metering with non-automatic lenses.

Consult your camera instruction manual for the "stopped-down" metering procedure. Note: Camera light metering systems will *not* work for astronomical photography.

#### Solar Photography

By placing the Celestron solar filter on the front of your Celestron and attaching your camera using the T-adapter and T-ring, you may safely make highly detailed photographs of sunspot groups in black and white or in full, natural color. Using readily available color films, exposure times will range from 1/15 second for ASA 64 films to 1/30 second for ASA 200 films. Use an air-release cable to trip your camera's shutter. You should bracket to be assured of correct exposure.



## Lunar Photography

The standard T-adapter and T-ring will allow you to photograph a large portion of the lunar disc at one time at the the Cassegrain focus of your Celestron. Depending upon the phase of the moon, exposure times on ASA 64 color film will range from 1/125 second at crescent phase to 1/125 second at full moon.

Focus carefully on craters near the terminator. Use an air-release cable and lock up the reflex mirror of your camera (if possible) or use a self-timer to minimize vibration.

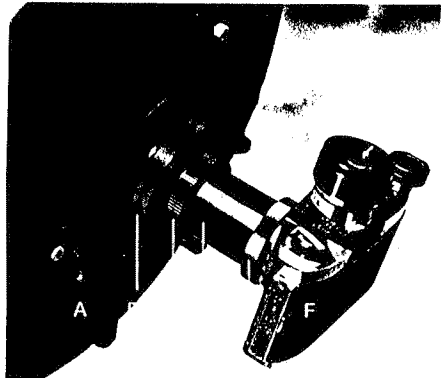

The T-Adapter

(This configuration of the camera on the telescope is called Cassegrain Focus photography.) (A) C14 rear cell (B) Reducer plate (C) Slip ring (D) T-adapter (E) T-ring (F) Camera body (no lens).



Burrowing owl at 80 feet



People in boat—approx. 300 meters

## Terrestrial Photography/Series VI Filter Set

Despite having the name "telescope" associated to your Celestron C11 or C14, you will find that your Celestron is a very powerful telephoto lens that can be used for a variety of terrestrial photographs. For terrestrial photography you should attach your camera body to the rear cell of the Celestron with a T-ring and T-adapter. You can use your camera's internal light meter during daytime photographs and you control your exposure by changing the camera's shutter speed, selecting different speed films, and by use of our Series VI drop-in filters. (The Series VI drop-in filter set has six filters that fit between the C11/C14 reducer plate and the T-adapter. The set includes: #1A skylight, #8 yellow, #11 yellow-green, #25 red, #80A blue, #96 neutral density.)

The photographs on this page were taken with the C11 during a one-morning session. A cable release was used as was the camera's mirror lock-up feature, to reduce image degrading vibrations.



Terrestrial Photography

Gloriosa daisies at 80 feet



50mm comparison



50mm comparison

## Lunar and Planetary Photography (Eyepiece Projection Photography)

Although Cassegrain-focus photography is great for small-scale renderings of the moon and planets, extremely long effective focal lengths (EFL's) are necessary to photograph finer details and to get a reasonably large planetary image on film. To do this, we supplied the tele-extender with your Celestron.

This particular photographic setup is known as the "eyepiece-projection" method. Here the ocular acts as an enlarging lens, projecting a magnified Cassegrain-focus image onto the film. The effective focal length may be varied by replacing the ocular with one of a different focal length. The most useful oculars for eyepiece-projection are the 25mm, 18mm, and 12mm. (Refer to the Reference Table at the back of this manual for the calculated EFL's).

To attach the tele-extender, first thread the 3"-2" reducer plate onto the rear cell. Now thread the 1 1/4" visual back onto the reducer plate. Next, insert the ocular and *tighten the set screw firmly.* (This will prevent the ocular from falling out later and damaging your camera).

Now thread the tele-extender over the ocular onto the visual back. Finally, thread your camera with the T-ring onto the tele-extender.

Successful high magnification photography is extremely dependent on steady seeing conditions. Therefore, shoot only when the seeing is steady.

Focus very carefully. If the object is too dim for easy focusing, try focusing on a bright, nearby star and then moving the telescope back to the desired object. If your camera has interchangeable focusing screens, change to a perfectly clear (aerial image) screen. This results in a significant improvement in apparent image brightness and makes focusing much easier and more precise.

Use an air-release cable to trip the camera's shutter. It's also a good idea to manually retract the camera's instant-return mirror and wait a few seconds for the vibration to damp out prior to making the exposure, or use a large black card in front of the telescope to act as a manual shutter.

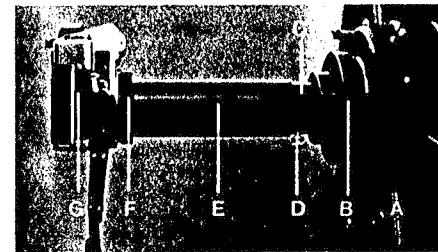

The Tele-Extender

(A) C14 rear cell (B) Reducer plate (C) 1 1/4" visual back (D) Set screw (E) Tele-extender (F) T-ring (G) Camera body (no lens).

Exposure times will vary greatly depending upon subject brightness, the EFL and resulting f-number, and film sensitivity (ASA rating). For example, when using the tele-extender with an 18mm ocular and ASA 200 film, the exposure time for Jupiter and the lunar terminator is approximately 1 to 2 seconds; for Saturn, about 4 seconds; for Mars at a "close" opposition, about 1/2 second; and for Venus, about 1/15 second.

Don't be disappointed if your first photographic efforts aren't all that you had hoped for. Remember, even professional astronomers have to take many pictures in order to get one really good one.

## Deep Sky Photography

With a little experience in lunar and planetary photography, you'll be ready to take on deep-sky photography with your Celestron. Deep-sky photography is a fascinating and highly rewarding experience, but you'll have to do a lot of experimenting to duplicate the amateur astrophotographers published in *Astronomy*, *Sky and Telescope*, *Star and Sky* and other periodicals.

Here are a few basic guidelines for the beginner:

The brightness of stellar and nebulous images at the focal plane is not governed by the same rule. The brightness of a star is determined by the square of the aperture of your telescope. A star is four times brighter in a two-inch telescope than it is in a one-inch telescope. But a nebula is not necessarily four times brighter.

The brightness of nebulae depends on the square of the focal ratio or f-number of your telescope. This is because nebulae—and many star clusters too—appear in your telescope as virtually uninterrupted areas of light, not point sources. The larger your f-number, the dimmer the images of these objects. A nebula is four times brighter at f/5 than it is at f/10.

The brightness of celestial images as they appear on film depends on another factor too: film speed or ASA rating. A film rated ASA 400 is four times faster, or more sensitive to light, than a film rated ASA 100.

Does this mean, then, that if you see a picture of a nebula made at f/5 with a 10-minute exposure on ASA 100 film you can get the same image density at f/10 in a 10-minute exposure on ASA 400 film? You'll probably get a similar density, if you use a film of the same "color" and if the atmospheric conditions are equivalent. Your film, however, will be faster and grainier, so you'll lose some detail.

Well, what about making a 40-minute exposure at f/10 with the same type of ASA 100 film used in the original photo? Here, you'll probably get less image density because of a reciprocity failure. This is the inability of film to respond as well to low levels of light over long periods of time as it does to higher levels of light over shorter periods of time.

Because of this problem, Kodak makes special 103a series spectroscopic films (i.e., low reciprocity failure) specifically for astrophotography. These films, 103aE (red sensitive), 103aO (blue sensitive), and 103aF (panchromatic) are available from several companies that advertise in the astronomical magazines listed at the back of this manual. Type 103aO is best for galaxies and reflection nebulae; 103aE is best for diffuse (emission) and planetary nebulae; 103aF is good for all deep-sky objects.

With these guidelines, you can enter the exciting realm of deep-sky photography.

## Constellation ("Piggyback") Photography

This is the simplest form of deep-sky photography. To photograph the constellations, you simply mount your camera with its lens "piggyback" on your telescope. The piggyback camera mount supplied with your Celestron makes this easy to do. When the camera is focused at infinity, loaded with fast color slide film, diaphragm wide open and the shutter opened for two to 10 minutes, with the clock drive on (and from a dark sky) we can almost guarantee stunning results.

To install the piggyback mount on the scope, loosen the set screws holding the counterweight bar in place, slide the bar back and then slide the piggyback mount onto the bar. Re-insert the counterweight bar back into its bracket and tighten the set screws. Position the piggyback mount on the counterweight bar so that the camera and lens center-of-gravity will be over the fork tines and tighten the set screws securely. The camera mounting screw has the standard 1/4-20 tripod thread.

The telescope will serve as a stable guiding platform. Make your exposures with either the 50mm lens of your camera or a telephoto lens. Guide with an illuminated reticle eyepiece inserted directly into the visual back of your telescope. Good films are Ektachrome 400 (color) and Tri-X (B&W) or the 103 series, all by Kodak.

Surprisingly dramatic wide-angle celestial portraits are possible with this technique using photographic speeds of 1/2 or so. Moreover, the smaller image scales will let you "hide" some of the guiding errors that would show up at the larger image scale of your Celestron. In short, constellation photography is a good way to practice your guiding. Start out with your 50mm lens and exposures



**The Piggyback Mount**

(A) Piggyback mount (B) Counterweight bar (C) Counterweight bracket

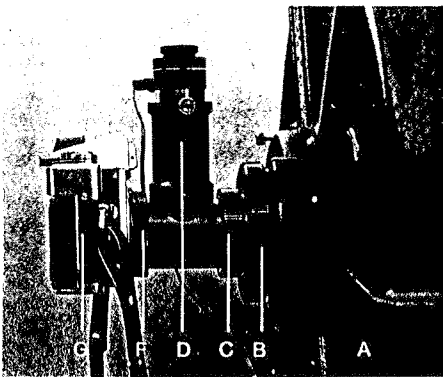

**The Off-Axis Guiding System (on a C14)**

(A) Rear cell (B) Reducer plate (C) Slip ring (D) Guider body (E) Illuminated reticle eyepiece (F) T-ring (G) Camera body (no lens)

of five or 10 minutes. When you can guide without error for 20 or 25 minutes, move up to a telephoto lens. (Focal length 75 to 500mm).

#### **The Off-Axis Guiding System**

While lunar and planetary photographs are essentially snapshots, time exposures are required to photograph star clusters, nebulae and galaxies. At the photographic speed of your Celestron, exposures of deep-sky objects will range from 15 minutes to an hour or more (however, see the section on Electronic Image Intensifiers).

This means that the deep-sky photographer must contend with a factor that is of little concern to the visual observer or to the planetary photographer who has lined up properly with the celestial pole. This factor is image drift. Image drift is caused by misalignment with the pole, by atmospheric scintillation and by long-period irregularities which are inherent in the mechanics of any clock drive.

To guide your telescope through a time exposure, you need a way to establish an in-the-field reference for image drift. You also need a way to guide at a much higher power than is equivalent to the image scale you're shooting at. The simplest and most economical way to meet these needs is to use the Celestron Off-Axis Guiding System. This optional accessory uses a tiny prism to divert light from a star at the edge of your photographic field up into a high-power 12.5mm ocular with illuminated cross hairs.

To attach the off-axis guider, first thread the 3" to 2" reducer plate onto the rear cell and then thread the guider onto the reducer plate. Attach your camera to the guider with a T-ring.

Using the slip-ring of the guider, rotate the unit until a suitably bright star appears in the field of the ocular.

The task of finding a guide star in the field of the guiding eyepiece will be greatly simplified if you use the following technique:

After attaching your camera, locating the object, and focusing, look through the finder telescope for a suitable guide star near the subject. Loosen the slip-ring of the guider and rotate the guider until the eyepiece "neck" is pointing in the same direction as the guide star appears to be through the finderscope. Only a small amount of additional searching will be necessary to get the guide star you've selected centered in the field of the guiding eyepiece. The R.A. and Dec. slow motions may be used for this purpose.

Chances are that if you can't see a potential guide star through the finderscope, it will be too faint to use successfully.

Focus on the guide star by raising or lowering the guiding ocular. You should focus the image of your subject in the camera before focusing the guiding ocular.

Using one of the optional drive correctors, your task is to keep the guide star centered on the intersection of the cross hairs for the duration of the exposure. Many people find it helpful to orient the cross hairs so that movement along one cross hair is in R.A. and movement along the other is in declination.

The cross hairs of the guiding ocular are illuminated by a red LED, which is held in the eyepiece by the set screw at the side of the housing.

The guiding-eyepiece LED is powered by a 9 volt battery, which has an on-off switch with a variable brightness control. Adjust the brightness of your LED to a level suitable for your guide star, but illuminate the cross hairs of the ocular no more than necessary.

#### **Photographic Guide Scopes/ The Celestron Tangent Assembly**

A guide telescope may be used instead of the off-axis guiding system for guiding during long photographic exposures, if desired. The process of finding a suitable guide star is greatly simplified with a guide scope because Celestron's tangent coupler assembly allows you to select any star up to 2 1/2° away from the object being photographed. In other words the guide scope can be pointed independently from the main telescope. To mount a guide scope on the C14, you must first remove one counterweight bar and bracket. The tangent coupler's attachment screws thread into the holes where the rear counterweight bracket is normally mounted. The C11 has mounting holes for the tangent coupler that are filled with plug-up screws on one side and by the counterweight bar on the other. The tangent coupler bolts to a radius plate (C11) or directly to the rear cell when you put on a C14 modified tangent base. On the C14 the guide scope must be removed from the tangent coupler. Unscrew the vertical adjustment screw completely and tilt the 1/4x20 mounting screw and base assembly up to gain access to the mounting screws. Next, thread the horizontal adjusting screw to the right (or left) until one of the mounting holes is exposed. Insert one of the mounting screws and thread it into the C14 rear cell until it's just finger-tight. Now thread the horizontal adjusting screw to the other side so that the other mounting hole is exposed and thread in and tighten the mounting screw. Thread the horizontal adjusting screw back to the other side again and tighten the first screw. Finally, remount the guide scope on the tangent coupler. Any guide telescope with a standard 1/4x20 threaded hole on its mounting bracket will bolt onto the Celestron tangent coupler easily with the large knob on the mounting bolt. Among Celestron products the C90 or C5 can be used as guide telescopes for the C11 or C14. The C5 is recommended for the C14.

To use the C5 as a guide scope, for example, first center the C11 or C14 on the object you wish to photograph. Use the vertical and horizontal adjusting screws on the tangent assembly to position the guidescope on a suitable guide star. Be sure to snug down the lock nuts after you have located the guide star.

Please note that use of a separate guide scope places unusual demands on the rigidity of the system and on the photographer's techniques. Any movement of the guide scope relative to the main scope will show up as image trailing on your photograph. If your brow just momentarily touches the guiding ocular during an exposure, the picture can be ruined.

At the Cassegrain focus of the C14, you will be photographing at 78x. Because of the shorter focal length of the C5, the illuminated reticle ocular provides a guiding magnification of only 100x. This means that the guiding-to-photographing magnification ratio is only 1.3:1. For this reason, the best results will be obtained if you use a 3x Barlow (3.8:1 guiding ratio) or a 2x Barlow (2.6:1 ratio) with the C5 Photo Guide Scope (two 2x Barlows stacked together will give a 5.2:1 guiding ratio). Similarly, a Barlow lens should be used with the C90 when used as a guide telescope.

Note that our price list does not show a guide scope. To use one of our instruments as a guide scope you must order the Optical Tube Assembly, the Tangent Assembly and the Illuminated Reticle Ocular Assembly. (You need a Reducing Bushing to adapt the I.R.O.A. to the 5" or C90).

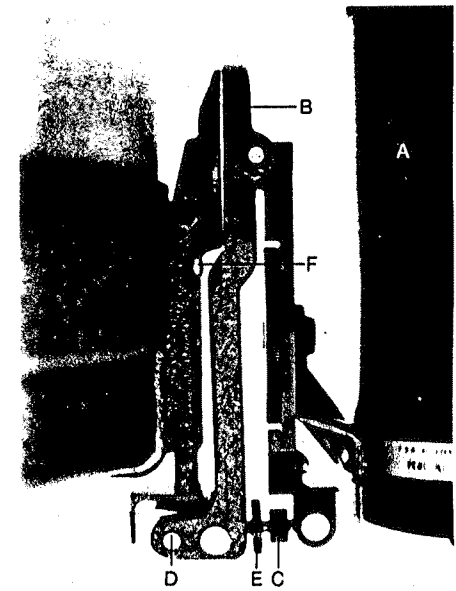

**The C-5 (1250mm Telephoto) As A Guide**  
(A) 1250 Telephoto shown (B) Tangent coupler (C) Vertical adjusting screw (D) Horizontal adjusting screw (E) Lock nut (F) Tangent coupler mounting screws

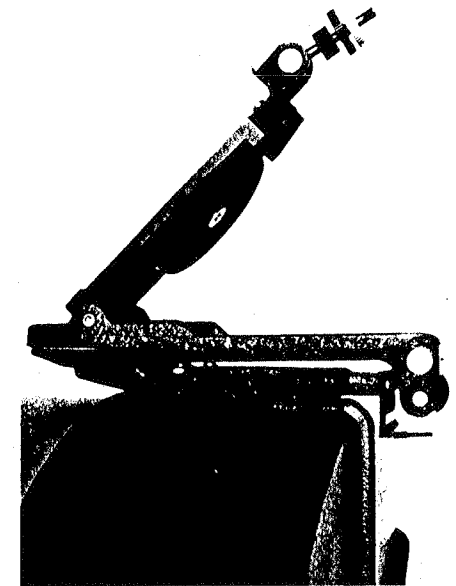

Tangent assembly opened for attachment via set screws

## Drive Correctors

Celestron offers three drive correctors for adjusting the position of your telescope in R.A. (East West) specifically for when you are attempting deep sky photography. You must be able to correct for image drift in R.A. during a long time exposure simply because a piece of film is unforgiving and will record any drift, if uncorrected and because no telescope has a perfect drive system (even large observatory telescopes).

1. *The Drive Corrector* (allows guiding corrections in R.A. only; applicable for both C11 and C14)

The Celestron Drive Corrector makes it possible for deep-sky photographers to correct for image drift in R.A. by speeding up or slowing down the telescope's drive motor. Located on the remote control paddle, the fast (85 Hz) button increases the drive speed by 42% and the slow (40 Hz) button decreases the speed by 33%. In addition, a vernier control allows you to dial in other rates you may desire—lunar, sidereal, or planetary.

Also included is a low-voltage map-and-chart light. Its brightness is controlled by a rheostat on the front panel of the unit. The lamp is a red LED.

The corrector, which is rated for up to 20 watts output, operates on 120 volt 60 Hz household current (unless ordered differently). It will also provide stable 120 volt 60 Hz current from a 12-volt D.C. automobile battery. For a normally charged battery, the charge drain during an entire evening is insignificant. NOTE: The R.A. drive motor may operate somewhat noisier than usual when the Drive Corrector is used.

Operating instructions are supplied with the drive corrector.

2. *The Dual-Axis Drive Corrector* (allows both guiding and slewing in R.A. and Dec. for the C11)

The Dual-Axis Drive Corrector incorporates all the advantages of the Drive Corrector (# 1) with the addition of a belt drive motor attached to the fork arm of the C11 so that declination corrections at guiding and slewing rates can be made. One hand control box contains all the controls to slew and guide the C11 in any direction; a switch on the hand control varies the rates from slow to guide. A bracket is available to attach the declination motor of the Dual-Axis Drive Corrector onto the C11 fork mount; power to the declination motor is provided by the electronics in the main chassis of the Drive Corrector unit. The declination motor is available as a separate unit for Celestron users with older Drive Correctors (these units are powered by a small battery pack), see Celestron's Retail Price Sheet and the Electronic Aids Operating Manual.

3. *Heavy Duty—C14 Drive Corrector* (provides slewing and guiding in R.A. and Dec. motions for the C14)

Celestron also offers a heavy duty Drive Corrector especially for people who want to use the C14 in remote field locations. The heavy duty C14 Drive Corrector has a higher power output to better handle the C14's electrical requirements. The heavy duty C14 Drive Corrector has a hand control panel that has both slew and guiding corrections built in. The hand control box operates the C14's slewing drive motors and will vary the R.A. power's frequency for fine guiding during astrophotography. Operating instructions are in Celestron's "Electronic Aids for Telescope Clock Drives". Note that the slewing motor speed selector must be switched to the higher speed for the slewing motions to operate through the Heavy Duty Drive Corrector's hand control box. (This unit will work with the C11).

## The C11 Optional Declination Motor

Available separately, or incorporated into the Celestron Dual-Axis Drive Corrector, Celestron offers a declination motor for the C11. The declination motor must be attached to the fork arm with a mounting bracket. A belt drive connects the motor pulley and the declination slow-motion control knob.

The Celestron declination motor operates at two speeds, a slow guide rate for corrections during long exposure astrophotography, and a fast slew rate for positioning of the telescope and scanning extended objects. The slew rate is not for moving the telescope from one region of the sky to another that's quite some distance away, say 5 degrees; the slew rate is for limited scanning and positioning of the telescope. The major advantage of the declination motor is that you can guide or slew via an electric control that is much more vibration-free than manual adjustment.

## The DC Inverter

For those individuals who are not interested in long exposure astrophotography but would like to operate their Celestron from a 12-volt DC power source, Celestron offers the DC Inverter. Its basic function is to provide a stable source of 120-volt AC power for clock drive operation from a car battery or any 12-volt DC source. The inverter also includes a variable-speed control and low-voltage map-and-chart light with a rheostat control.

As with drive correctors, it is normal for a clock drive to run somewhat noisier when using the inverter.

## The Tele-Compressor

To be able to decrease your exposure time in deep-sky photography and yet retain the same image density on film is to be able to reduce the effects of atmospheric scintillation and guiding errors on your photographs. For this, we offer several photographic accessories: the Tele-Compressor, the Cold Camera, and the Schmidt Camera.

The Tele-Compressor reduces by one-half the effective focal length of your Celestron. It, therefore, increases the photographic speed of your instrument and lets you reduce to one-fourth the exposure time for a given image density. With this accessory, your image scale is also reduced, by a factor of two, resulting in a circular format about .8 inch in diameter on the negative. A large Tele-Compressor is available to better fill a 35mm format.

The Tele-Compressor is a converging lens mounted in a housing that threads onto the back of the Off-Axis Guider. The housing accepts your camera ring and camera body.

Since the Tele-Compressor lens mounts behind the prism of the Off-Axis Guider, the guiding eyepiece will focus at a position further away than normal. To accommodate this change, an eyepiece extender is supplied.

## The Celestron-Williams Cold Camera

Due to the insensitivity of certain films to faint light, photography of dim, nebulous objects at the Cassegrain focus of a telescope requires long exposure times. Because of reciprocity failure in films, doubling the exposure time will not double the image density of the negative. This means that fainter objects require disproportionately longer exposure times to record satisfactorily on film. Color films are even less sensitive to faint light than black and white films and require even longer exposure times. Additionally, the color balance of color films can change radically during long exposures.

To help solve these problems, Celestron offers the optional cold camera. The cold camera greatly increases film sensitivity (3 to 6 times for color films and up to 15 times for B & W) and practically eliminates any shift in color balance.

The cold camera increases film speed by chilling the film to sub-zero temperature thereby greatly reducing reciprocity failure. The cold camera, which uses dry ice for cooling, is available in 35mm format and couples to the off-axis guiding system.

The cold camera makes it possible to obtain spectacular color photos similar to those seen reproduced in astronomy magazines and text books. The only limitations are your photo techniques and guiding ability.

It is our experience that the Cold Camera, coupled with modern films yields more aesthetic photographic results for less effort than any other method of color deep sky astrophotography. Recent developments in gas-hyper-sensitized films holds promise and have shown excellent results in black and white astrophotography but the color results have thus far been disappointing although experimentation continues.

In our opinion, the finest, non-Schmidt Camera, color astrophotographs come from large aperture, long focal length telescopes using off-axis guiding systems, and a cold camera under clear, stable skies at higher elevations.

The Cold Camera works well with Tri-X, Ektachrome 200 and Ektachrome 400. There are other films that work well as you'll discover when exploring the exciting art of astrophotography.

## The Celestron Schmidt Camera

The ultimate optional accessory for wide-field high resolution photography is the Celestron Schmidt Camera. Its extreme photographic speed allows you to photograph the heavens with readily available color and B & W films using relatively short exposure times. Its large photographic field allows you to capture, in intricate detail on a single negative:

- The entire North America Nebula and companion, the Pelican Nebula, with their red fluorescence and ink-black patches of dust.
- Both halves of the Veil Nebula, with their blue and rose-pink tracteries set against the starry background of the northern Milky Way.
- All of the Double Cluster in Perseus, with its fiery orange super-giants scattered throughout and its hundreds of outliers.
- The complete spiral of the Andromeda Galaxy, its dust lanes backlit by the pale yellow glow from within and by the presence of young blue-hot stars from without.
- The Orion Nebula and the Horsehead Nebula, with their dark clouds of obscuring matter etched sharply onto their pastel red, yellow and blue luminosities.
- All of the Pleiades, blazing like sapphires and enveloped in the blue, brushstroke nebulosity familiar to all readers of textbooks in astronomy. And these are only the beginning.

The Schmidt cameras easily mount on Celestron telescopes using existing mounting holes. Request the publication, "The Celestron Schmidt Camera" (price \$1.00) for complete mounting and operating instructions.

## Large Aperture Telescopes and Electronic Image Intensifiers

Neophyte astronomers often believe that a simple look through a telescope, of any size, will yield a visual image of deep sky objects similar to the photographs taken

through the great observatory reflectors. We wish it were so. Unfortunately, the light from a distant galaxy or cluster that enters through the telescope cannot always trigger the eye into "seeing" because of the low light levels. Film has the advantage of being able to store up the light over a long time exposure to make one final, but beautifully detailed, photograph.

But this situation has changed. New electronic image intensifiers have become available to amateur astronomers. Image intensifiers electronically amplify the light that comes through the instrument to give on its display/view screen a much brighter image, brighter by perhaps up to 60,000 times! This means you can use an image intensifier to see faint galaxies and extend nebulosity without really trying. We do make the qualifications that you will not see the image in color because the image intensifiers take all colors of light and put out a monochromatic (one color) display as does a black and white television. The color of an image tube display is usually a soft green and the resolution is not as high as visually looking through the instrument. Note also that image contrast is not increased.

Not only are visual observations greatly enhanced but you have the ability to photograph faint stars and other objects with incredibly short exposures. Since the images produced by image intensifiers are monochromatic, you photograph with black and white film. As an example, the photograph below of M51 was taken with the C14, on electronic image intensifier and an ordinary camera using sensitized Tri-X film. The exposure was only five minutes. When the telescope is properly aligned such a photograph may not need any guiding at all. As you can see the image intensifiers are revolutionizing astronomy and astrophotography with exposure times reduced to perhaps 1/100 of what they were before—no more hours spent at carefully guiding an exposure!

The scientific and esthetic utility is limitless when you couple an image intensifier to a telescope. Celestron does not offer these miracles of modern electronic wizardry but the names of several suppliers can be found in astronomical journals such as "Sky & Telescope." The costs are still high, in the order of thousands of dollars but prices are coming down and what you are buying is an electronic means to greatly increase the aperture of your telescope.

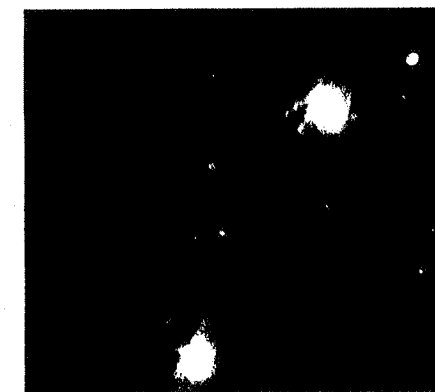

The Whirlpool Galaxy (M51). A 5-minute exposure with an image intensifier on a C14. Photograph by Ben Mayer.

### The Permanent Pier

For institutions or individuals who desire to permanently mount the C11 or C14 in an observatory, Celestron will fabricate the optional permanent pier to your specifications (you must specify the latitude of the observatory site). The pier, which takes the place of the equatorial wedge and tripod, is constructed of 10" diameter steel pipe (weight is approximately 200 lbs.) and is the most stable mounting available for these large telescopes.

The pier should be placed 2 feet south of the center of the observatory dome in order to center the telescope tube under the dome. Final, precision polar alignment may be accomplished by shimming the pier.

The protection and usefulness of any telescope is tremendously magnified when the telescope is placed within an observatory dome with a pier. Contact dome suppliers, listed in appendix VIII, for specifications on domes. A dome 10 feet or 2m and larger will fit the C14/C11.

### The T-to-C Video/Movie Camera Adapter

This accessory is offered for the many movie camera enthusiasts who wish to record the action at a distance.

Used in conjunction with a Celestron T-Adapter it couples almost all 16mm movie cameras, most video cameras, and some of the more expensive and sophisticated Super 8 cameras (those with removable lenses) to the back of your Celestron.

Aside from making distant action accessible, this device provides for convenient group observing with a TV camera and video monitor.

Because of the weight, bulk, and vibration of a movie or video camera, we strongly advise fabricating a solid mounting bracket to couple the camera rigidly to the back casting of your Celestron. For additional information on motion-picture photography, and a suggested bracket design, request our publication entitled *Celestron Multi-Purpose Telephotos* (price \$1.00).

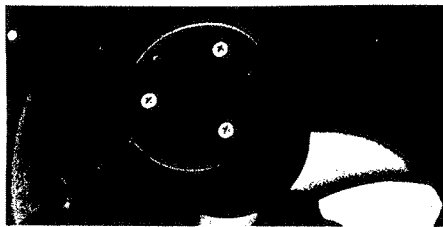

C11 Collimation Adjustments



C14 Collimation Adjustments

Collimation is accomplished simply by adjusting the three outer screws on the secondary housing. **DO NOT FORCE THESE SCREWS.** The adjustments are very sensitive.

### Caring for Your Celestron

These are two of the most maintenance-free telescopes ever manufactured. But from time to time, adjustments will be needed, and there are certain precautions that must be taken. Celestron has a full service/repair department should you desire assistance.

### Collimation

More than half of all telescopes perform poorly because their owners are not acquainted with the technique of collimation—the technique of aligning telescope optics. Your Celestron was collimated at the factory, but if it is jarred severely or undergoes sustained jostling, it might have to be recollimated.

Contrary to popular belief, collimation is a relatively simple procedure. Collimation simply means that the optical centers of the optical elements are square-on with each other, or perpendicular to the optical axis. THE ONLY COLLIMATION ADJUSTMENT THAT IS NECESSARY, OR POSSIBLE, WITH YOUR CELESTRON IS THE TILT ADJUSTMENT OF THE SECONDARY MIRROR.

To check collimation, you'll need a proper light source. A bright star near the zenith is best (to minimize atmospheric scintillation), but Polaris will do also.

During collimation, incidently, your telescope should be in thermal equilibrium with its surroundings. If you transport the instrument between very great temperature extremes, allow about 45 minutes to 1½ hours for it to reach equilibrium.

Now, using your 25mm eyepiece, defocus the telescope so the out-of-focus blur circle of your light source occupies about a sixth of the field-of-view with the star at the center of the field-of-view. If the shadow of the central obstruction (secondary housing) is not perfectly centered inside the blur circle, your telescope is out of collimation. (Even if the shadow appears centered, read on.)

To adjust your collimation, use your slow-motion controls to re-point the telescope so that you move the blur circle to the edge of the field in the direction that the shadow is off-center. Then, using the three Allen screws at the edge of the secondary housing, bring the blur circle back to the center of the field.

Tighten the screw(s) in the direction that the shadow is off-center and loosen the other screw(s), tightening the screw(s) to finger-tight only. Repeat this process until the blur circle is again at the center of the field.

**CAUTION: THE TILT ADJUSTMENTS OF THE SECONDARY ARE VERY SENSITIVE. GENERALLY, A TENTH OF A TURN WILL COMPLETELY CHANGE THE COLLIMATION. DO NOT FORCE THESE SCREWS. BE SURE TO KEEP AT LEAST ONE SCREW UNDER TENSION AT ALL TIMES SO THE SECONDARY DOESN'T ROTATE ON ITS SUPPORT. ON C14'S DO NOT TURN OR ADJUST THE CENTER SCREW ON THE SECONDARY HOUSING. THIS HOLDS THE SECONDARY MIRROR IN PLACE!**

With the blur circle again centered in the field, you might find that the shadow of the central obstruction is still off-center a bit. Repeat the collimation process until the shadow is perfectly centered within the circle.

Then, using successively higher-powered oculars, until you reach the highest powered ocular you will be using, repeat the collimation process as necessary. Collima-

tion at the higher powers (6mm up) is best accomplished with the telescope in focus, if the seeing is good. Collimating in focus, you will be observing the Airy Disc instead of the shadow of the central obstruction. This will appear as a bright ball with a diffraction ring around it. When the ball is exactly centered inside the ring, your telescope is collimated.

### Lens Care and Cleaning

When your telescope is not in use, place the lens cap on the front cell, cap the rear-cell opening and store the telescope in your carrying case. Do this regularly and your telescope may never have to be cleaned internally or have to have its mirrors realuminized.

The corrector lens should be cleaned only when necessary. To remove loose dust or dirt particles, use a can of pressurized air or a camel's hair brush. Then a photographic lens cleanser may be used with white "Kleenex" or a non-silicon photographic lens tissue to clean your corrector. The compressed air or lens brush can be used to remove any remaining lint.

**DO NOT CLEAN THE CORRECTOR WITH VIGOROUS CIRCULAR MOTIONS! USE A NUMBER OF TISSUES, AND TAKE A SINGLE, GENTLE WIPE FROM THE CENTER OUT WITH EACH TISSUE.**

Optics coated with magnesium fluoride are best given special care. A good cleaning solution is ½ isopropyl alcohol, ⅓ distilled water and two drops of biodegradable liquid dish detergent per each quart of solution. (Soap by itself will leave a film.)

Be sure to store your oculars and other visual accessories in a dust-free environment when they are not in use. Celestron oculars have a thin anti-reflection coating. If they need cleaning, use the formula above. You can form a little brush out of a piece of white "Kleenex" tissue to get the edges of the lenses. In tropical, humid climates you may wish to keep the instrument stored near a light with a clear lens cap to prevent mold from growing inside the telescope tube.

In cleaning the optics of your Celestron, you might notice hairline streaks or tiny pits on the optical surfaces of the primary, secondary or corrector. There is no cause for alarm. These do not affect the optical performance of your telescope.

Also, if moisture has settled out onto your optics, and you are examining them at night with a flashlight, you might notice streaks on the elements produced during the final cleaning. Again, there is no cause for alarm. These do not affect the quality of your telescope.

**NOTE ON THE FLASHLIGHT TEST**—The reflectivity of the mirrors of your Celestron is typically 93%. The transmission of the corrector is about 95% at each surface. This means that 7% of the light impinging at each mirror surface is scattered and 5% of the light transmitted at each surface of the corrector is scattered.

If you use a high-intensity beam at night on these surfaces, so that the beam isn't played directly into your eye and the pupil remains essentially dark-adapted, then this small amount of scatter appears much larger than it is. Under these conditions, even perfect optics may appear "terrible."

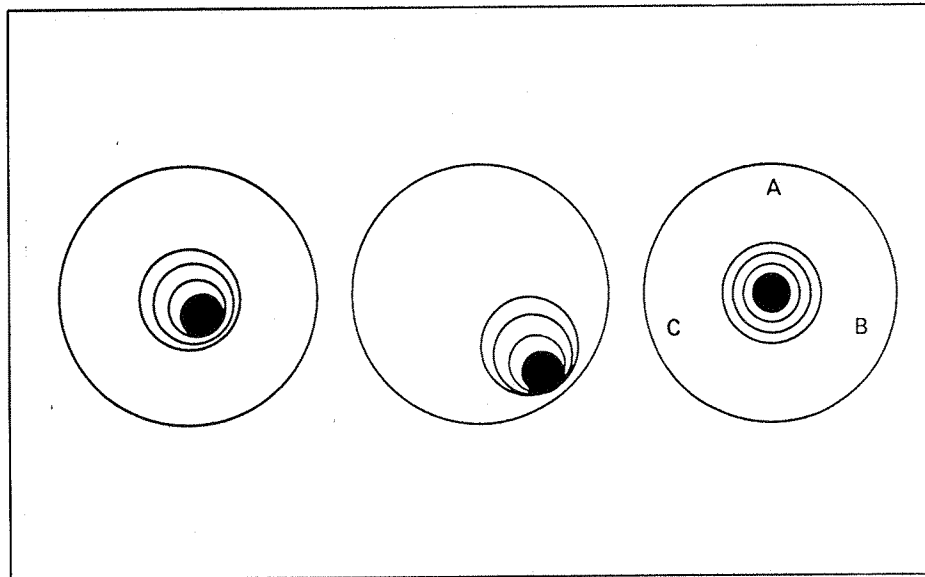

The Image During Collimation

**LEFT:** Blur circle in the center of the field of your telescope. Secondary shadow within the circle is off-center. Your scope is out of collimation. **MIDDLE:** To recollimate, re-point your telescope to move blur circle to edge of field in direction shadow is off center. **RIGHT:** Then move circle back to center of field by tightening and loosening appropriate collimation screws. Here you tighten screw B and loosen A and C. (The screws are oriented as seen from the back of your telescope.)

## Demounting the Optics

If by chance the inside of the corrector needs cleaning, follow these instructions. Be careful!! Not only is the corrector plate thin, it must be replaced in exactly the same orientation it was prior to removal. This is for reasons of collimation and also because both corrector and secondary mirror position-matched for optical performance with respect to the primary. You should tilt the tube with the corrector facing in the upward position.

To remove the corrector lens, unscrew the eight set screws and remove the corrector retaining ring. After removing the corrector retainer, you'll see a code number etched onto the edge of the corrector. You'll also see some cork shims between the edge of the corrector and the front-cell ledge. These shims protect the corrector from shock and hold its optical center over the optical axis of your scope.

Before removing the corrector, pencil index marks on the inside of the front cell that indicate the precise positions of the corrector code number and each shim. Remove and number-code the shims so they may be returned later to the same positions.

You may now grasp the secondary mirror cell and lift the corrector out of the tube for cleaning.

Since the secondary mirror is mounted in the cell in the center of the corrector, it will also be removed by this procedure.

If necessary, the secondary may be removed by unscrewing the collimation screws on the front of the secondary mirror cell (and the center screw on the C14). When the secondary mirror is remounted, the index line on the back of the mirror must be pointing to the center of the code number etched on the corrector lens.

When replacing the corrector, align its code number with the index mark you made on the tube and return each shim to its proper position. When replacing the corrector retainer, tighten the screws down gradually, in round-robin fashion, to finger-tight only. This should be just barely tight enough to keep the corrector from moving whenever the telescope is repositioned.

**CAUTION: TOO MUCH TIGHTENING MAY CAUSE THE CORRECTOR LENS TO CRACK.**

## Adjusting the R.A. Clamp

The pressure plate activated by the R.A. clamps is subject to wear over a period of time.

To tighten the R.A. clamps, remove the clamp levers and tighten the exposed screws just enough so that you can't rotate the fork tines manually. Replace the clamp levers in the lock position, with it pointing to the left. When you unlock the clamps, the tines should swivel with a barely perceptible amount of drag.

## Adjusting the Dec. Clamp

Over a period of time, the Dec. clamp at the top of the fork tine may become too loose. To tighten the clamp on the C14, loosen the lock nut that holds the acorn-head screw in position, advance the screw and tighten the lock nut. For the C11, loosen the lock nut, advance the clamp and tighten the lock nut.

## Adjusting the Dec. Slow-Motion

Over a period of time, the action of the Dec. slow-motion may become too loose and cause noticeable backlash.

To tighten the Dec. slow-motion, loosen the lock nut at the end of the tangent screw and advance the cone-point screw until the Dec. control is tight enough.

Hold the cone-point screw in the desired position with your Allen wrench and tighten the lock nut with a wrench.

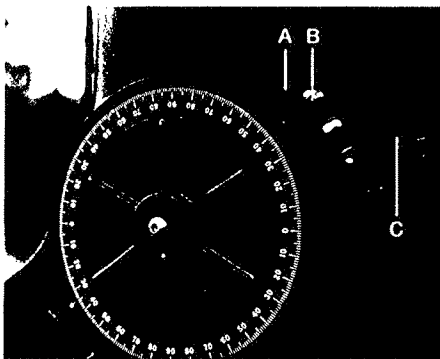

**C14 Declination Clamp**  
(A) Acorn-head screw (B) Lock nut (C) Clamp lever

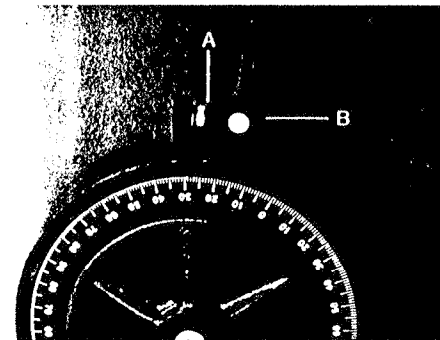

**C11 Declination Clamp**  
(A) Lock nut (B) Dec. clamp lever

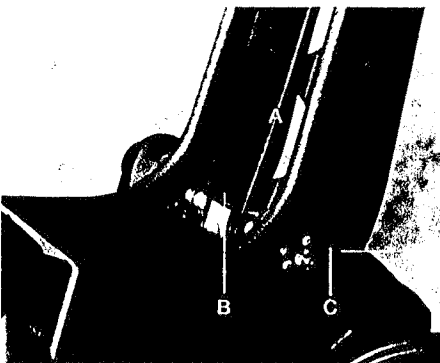

**The Dec. Slow-Motion-C14**  
(A) Tangent arm (B) Tangent screw (C) Lock nut (D) Cone-point screw

## Adjusting Worm Gear Drives

A worm gear drive system is simple in design. A worm gear (a gear with its axis perpendicular to the teeth) turns a worm wheel (a larger gear with its teeth parallel to the rotational direction). For smooth operation and minimal backlash, the worm gear should have firm contact against the worm wheel. Due to gear irregularities and frequent use the worm wheel and worm gear contact may need periodic adjustment and you may have to adjust the worm gear-to-worm wheel pressure. The worm gear needs adjustment when you can grab your Celestron's fork tines and find excessive play (say, approximately over 5-minutes on the R.A. circle) when the instrument is rocked in the east-west direction with the R.A. clamp firmly locked.

To adjust the C14 worm gear, take the mount off the tripod or pier. Remove the front control panel (disconnect all electrical cords first). Under the drive base you will find six bolts. The two smallest (Allen head) are used to adjust the tilt of the motor block (and worm gear) into the worm wheel. By adjusting these and the block they support inside the telescope drive (obvious when the drive is opened), you can adjust the pressure of the worm gear against the worm wheel. Begin by loosening the two large hex-head bolts closest to the C14 control panel; then use the small Allen head to tilt the worm into the worm wheel for better contact; loosen the inner (toward polar axis) bolts if necessary; do not lock the hex-head bolts too tightly or the plate may warp and change the gear adjustment. Do not jam the worm gear tightly into

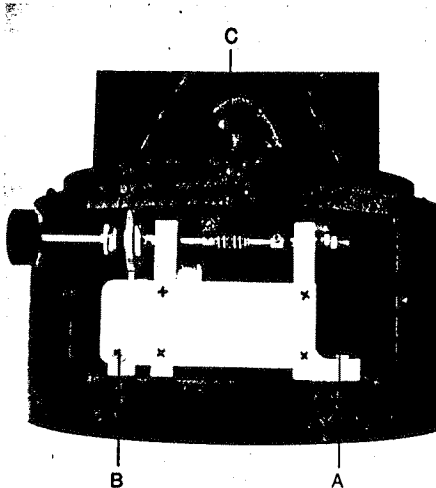

## Adjusting the Worm Gear—C11

Loosen screw (A) and adjust both nuts (B) to adjust the worm gear (C) pressure on the worm wheel (behind the worm gear). You can adjust the clutch by using a slender or filed down 9/16" wrench on lock nuts (D) you may tighten to hold the C11 from rotating if heavy accessories are attached, when the clutch is tight the R.A.—slow motion knob will be more difficult to turn. Note that some play is normal in the transfer gear from the electric motor.

the worm wheel or an erratic drive rate will result (as well as gear wear.) Reassemble and test. After you become familiar with the procedure you need not take off the front control panel.

To adjust the C11 worm, disconnect the telescope from any electrical power source. Remove the black plastic worm gear cover. Inside you will see that the drive motor and gearing is supported on a metal block. Loosen the two bolts on the right (looking into the drive base) that hold the motor assembly to the block and adjust the worm gear tension with the nut and bolt tension adjuster on the left. The gear should not be so tightly run up against the worm wheel that the R.A. slow-motion knob becomes too difficult to freely turn. Some backlash is to be expected and it may vary with position of the worm on the worm wheel—thus, you may want to adjust prior to any serious astrophotography.

## Returning Your Instrument for Service

Rarely is it necessary to return a Celestron for service. Most problems can be solved by telephone or mail.

Any problems (or adjustments) not covered by this manual should be discussed with our factory service personnel before any attempt is made to correct them. If it is decided that you should return your instrument for service, be sure to include along with your name and return address, a letter completely describing the problem and listing our recommendations.

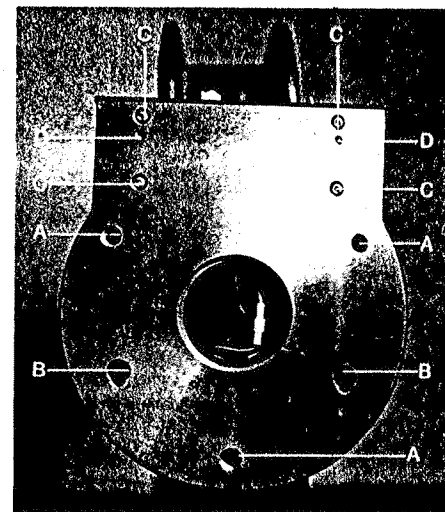

## Adjusting the Worm Gear—C11

(A) Base to wedge attachments (B) mounting pin receptacles (C) motor block mounting screws (D) worm gear tilt adjustment screws (adjust these after loosening C.)

## Appendix I Basic C11 Telescope Specifications\*

### Standard features in the base price:

The base price Celestron 11 is a complete working telescope and includes: Optical Tube Assembly, Visual Back-1 1/4", Star Diagonal-1 1/4", 10 x 40 Finderscope, Fork Mount, Setting Circles, Electric Clock Drive with worm gear, Clock Drive Cord, Piggyback Mount, Tele-Extender, T-Adapter, Counterweight Bar Assembly, 40mm-1 1/4" Ocular, 25mm-1 1/4" Ocular, 12mm-1 1/4" Ocular, Lens Cap, Carrying Cases, and Instruction Manual. Special Coatings, Wedge and Tripod are optional. (For other options see Celestron List Prices sheet.)

**Clear Aperture:** 11 inches (280mm)

**Light grasp** (compared to eye with 7mm pupil size): 1778x

**Optical design:** Schmidt-Cassegrain catadioptric; diffraction limited

**Focal ratio:** f/10

**Focal length:** 110 inches (2800mm)

**Highest useful magnification:** 660x

**Lowest useful magnification:** 42x (approx. a 65mm ocular)

**Photographic resolution:** 200 lines/mm (theoretical at 4100 angstroms)

**Standard oculars (eyepieces):** 40mm-1 1/4" 70 power; 25mm-1 1/4" ocular, 112 power; 12mm-1 1/4" ocular, 233 power. All oculars fully coated.

**Closest focus:** 70 feet (21.3 meters)

**Resolution (Dawes' limit):** 0.4 arc seconds (diffraction limit)

**Stellar magnitude limit:** (visual; approx.) 14.5

**Image scale:** 0.52 degrees/inch (= 0.02 degrees/mm)

**Photographic field of view:** 0.73 x 0.46 degrees on a 35mm slide format

**Primary mirror:**

figure: spherical

diameter: 11.2" (284.5mm)

f/ratio: f/2.02

radius of curvature: 44.5 inches (1131.6mm)

material: fine annealed Pyrex

**Secondary mirror:**

figure: spherical (final hand figuring yields a slightly aspheric figure)

diameter: 3.1" (78.7mm)

radius of curvature: 12.8" (325.1mm)

material: fine annealed Pyrex

amplification ratio: 4.95

**Central obstruction:** 4" (13.2% by area or 36.4% by diameter)

**Corrector plate:** true aspheric Schmidt curve on exterior; plane interior

**Thickness of corrector:** 3/16"

**Back focus:** 9 inches approx. maximum (from apex of primary)

**Mirror coatings:** enhanced aluminum; with silicon monoxide (SiO) protective overcoat

**Optional special coatings (on both sides of corrector plate only):** anti-reflection magnesium fluoride (MgF<sub>2</sub>); 1/4 wave thickness optimized for 540NM.

**Mount type:** fork

**Fork dimensions (max.):**

height: 26.5" (67.3cm)

width: 18.3" (46.5cm)

height of fork arm: 19 1/4" (from top of drive base) (48.9cm)

distance from center of declination axis to drive base:

16 3/4" (42.5cm)

distance from bottom of drive base to center of dec axis:

23 3/4" (59.4cm)

width of fork arm: 3 3/4" (9.5cm)

**Weight of fork mount and drive:** 29.5 lbs. (13.4 kg)

**Fork mount and drive castings:** sand cast aluminum; type 356-T6

**Optical tube assembly dimensions (max.):**

width: 12.5" (32cm)

length: 23.5" (60cm)

weight: 27.5 lbs. (13.8 kg)

**Tube construction:** aluminum (sand cast front & rear cell; tube alloy is 6061-T4)

**Drive system:** worm gear; solar drive rate

**Diameter of worm wheel:** 6 3/4"

**Number of teeth on worm wheel:** 216 (32 pitch, 14.5° pressure angle, pitch diameter 6.750 ± .001)

**Power requirements:** 110 volts, 60 Hz, 2 watts (other voltages and frequencies available)

**Slow motion controls:** manual standard on both axes (optional electric in declination)

**Declination slow motion rate:** 0.12°/revolution of control knob

**R.A. slow motion rate:** 1.8°/revolution of control knob

**Polar axis:** tapered

**Diameter of north ball bearing:** 1 3/4"

**Diameter of south ball bearing:** 2 1/4"

**Diameter of declination setting circle:** 5 1/2" (1° divisions)

**Diameter of R.A. setting circle:** 8 3/4" (5 min. = 1.25° divisions)

**Fasteners:** stainless steel

**Color:** orange and brown (3 coat, 5-step process-primary coat, flat coat, bake, spatter coat, bake)

**Interior color:** flat black baked enamel and flat black anodized

**Lens cap:** anodized spun aluminum

**Standard finderscope:** 10x40 (8x50, 10x70 or, extra 10x40 finder available as accessories).

**Filter provisions:** 1. Photographic: optional standard Series 6 drop in; install between T-adapter and rear cell of telescope. 2. Visual: Celestron eyepieces accept our optional eyepiece filters (.96", 1 1/4", 2" sizes available).

**Rear cell threads:** (Same as on rear cell of C5, C8, C14 reducer plate.) The C11 rear cell incorporates a removable C14 reducer plate for attachment of accessories via Universal Celestron Threads, 24 pitch thread, 2-inch diameter;

rear cell baffle-tube-lock-nut threads (that the reducer plate threads onto), 16 pitch thd./3.290" diameter

**Internal bore diameter of reducer plate:** 1.5" (38mm)

**Internal bore diameter of main baffle tube:** 2 1/4" (54mm)

**Weight of optional wedge:** 26 lbs. (12 kg)

**Latitude adjustment range:** Approx. 17°-60° (without latitude adjuster)

**Weight of optional tripod:** 33 lbs. (15 kg)

**Size of wedge's shipping container:** 10x14x23"

**Size of tripod's shipping container:** 49x13x12"

**Size of tube assembly case:** 16.5"x15.5"x30"

**Size of fork/accessory case:** 13"x16"x30"

Notes:

1. The C11 utilizes the same tripod as the C14.

2. The C11 drive base is shipped in a separate foam padded carton; it may be stored in the fork accessory case.

\*All specifications are approximate and Celestron International reserves the right to revise the instrument, accessories and specifications without notice.

## Appendix II Basic C14 Telescope Specifications\*

### Standard features in the base price:

The base price Celestron 14 includes: optical tube assembly, fork mount, electric clock drive with worm gear drive, giant 2" star diagonal, 1 1/4" visual back, 10x40 finderscope, setting circles, two counterweight bar assemblies, 1 1/4" oculars of 40mm, 25mm, 12mm, 6mm focal lengths, lens cap, carrying cases, instruction manual, electric slow-motions in R.A. and Dec., illuminator map light, piggyback mount, tele-extender, T-adapter, two counterweights, drive cord.

**Clear Aperture:** 14 inches (350mm)

**Light grasp** (compared to unaided eye): 2,580x

**Optical design:** Schmidt-Cassegrain catadioptric; diffraction limited.

**Focal ratio:** f/11

**Focal length:** 154 inches (3,910mm)

**Highest useful magnification:** 840x

**Lowest useful magnification:** 50x (7mm exit pupil)

**Photographic resolution:** 182 line pairs/mm (theoretical at 4100 angstroms)

**Standard oculars (eyepieces):** 40mm-1 1/4" Kellner, 100x; 25mm-1 1/4" Kellner, 155x; 12mm-1 1/4" Orthoscopic, 325x; 6mm-1 1/4" Orthoscopic, 650x.

All oculars are fully coated.

**Closest focus:** Approx. 100 feet (30.5 meters)

**Resolution (Dawes' Limit):** diffraction limited; 0.3 arc seconds

**Stellar magnitude limit (visual; approx.):** 15

**Image scale:** 0.37"/inch (= 0.014 degrees/mm) at Cassegrain focus

**Photographic field-of-view:** 0.35° x 0.51° on a 35mm slide format

**Primary mirror:**

Figure: spherical

Diameter: 14.25-inches (361.9mm) clear aperture.

f/ratio: f/2.14

radius of curvature: 60-inches (1,524mm)

material: fine annealed Pyrex

**Secondary mirror:**

Figure: spherical (final hand figuring yields a slightly aspheric figure)

Diameter: 3.50-inches (88.9mm)

Radius of curvature: 17.6-inches (440mm)

Material: fine annealed Pyrex

Amplification ratio: 5.14

**Central obstruction:** 4.5 inches (10% by area or 32% by diameter)

**Corrector plate:** true aspheric Schmidt curve on exterior, plane interior

**Thickness of corrector:** 1/4-inch (6.4mm)

**Back focus:** 14-inches approx. maximum (from apex of primary)

**Mirror coatings:** enhanced aluminum; with silicon monoxide (SiO) protective overcoat

**Optional special coatings (on both sides of corrector plate only):** anti-reflection magnesium fluoride (MgF<sub>2</sub>); 1/4 wave thickness optimized for 540NM.

**Mount type:** fork

**Fork dimensions (max.):**

Height: 37" (94cm)

Width: 23 3/4" (59.7cm)

Height of fork arm: 30 1/2-inches (77cm from top of drive base)

Distance from center of declination axis to drive base: 27 1/2-inches (69.8cm)

Width of fork arm: 3 3/4" (9.5 cm)

Weight of fork mount and drive: 58-lbs. (26 kg)

Fork mount and drive castings: sand cast aluminum; type 356-T6

**Optical tube assembly dimensions (max.):**

Width: 16-inches (40.6cm)

Length: 30-inches (76cm)

Weight: 50 pounds (23 kg)

**Tube construction:** aluminum (sand cast front & rear cells; tube alloy is 6061-T4)

**Drive system:** worm gear; solar drive rate

**Diameter of worm gear:** 6 3/4"

**Number of teeth on worm wheel:** 216 (32 pitch, 14.5° pressure angle, pitch diameter 6.750 ± .001)

**Power requirements:** 110 volts, 60 Hz, 2 watts

**Slow motion controls:** manual on declination; electric two-speed on both declination and R.A.

**Declination slow motion rate:** slow electric; 57 sec/degree—fast electric; 27 sec/degree

**R.A. slow motion rate:** slow electric; 1h32'/min—fast electric; 3h15'/min

**Polar axis:** tapered

**Diameter of north ball bearing:** -inches 4.724 O/D; 3.740 I/D

**Diameter of south ball bearing:** -inches 6.098 O/D; 5.966 I/D

**Diameter of declination setting circles:** 6-inches (1° divisions)

**Diameter of R.A. setting circle:** 9 1/2-inches (5 min. = 1.25° divisions)

**Fasteners:** stainless steel

**Color:** Celestron orange and Celestron brown (3-coat; 5-step process-primary coat, flat coat, bake, spatter coat, bake)

**Interior color:** flat black baked enamel or flat black anodized

**Lens cap:** black anodized spun aluminum

**Standard finderscope:** one 10x40 (additional 10x40, 8x50 and 10x70 available as accessories)

**Filter provisions:** 1) Photographic: optional standard Series 6 drop-in; these install between T-adapter and rear cell of telescope. 2) Visual: Celestron oculars accept our optional eyepiece filters (.96", 1 1/4", and 2" sizes available).

**Rear cell threads:** 16 pitch thd./3.290" diameter

**Reducer plate threads (reduces rear cell threads to Universal Celestron Threads):** 24 pitch/2 inch

**Internal bore diameter of reducer plate:** 1.5-inches (38mm)

**Internal bore diameter of main baffle tube:** 2 1/4-inches (54mm)

**Weight of optional wedge:** 26 lbs. (12 kg)

**Latitude adjustment range:** Approx. 21°-60°

**Weight of optional tripod:** 33-lbs. (15 kg)

**Height of tripod (top to ground—when set up):** 35 1/4" (89 cm)

**Case dimensions:**

**Tube assembly case:** 21 x 22 x 36-inches

**Fork/accessory case:** 12 x 21 x 36-inches

**Tripod shipping box:** 49 x 13x 12-inches

**Wedge shipping box:** 10 x 14 x 23-inches

\*All specifications are approximate and Celestron International reserves the right to revise the instrument, accessories and specifications without notice.

comp. (BA)

Appendix III  
The Messier Catalog

Coordinates						Coordinates							
Designation	R.A. (h/m)	Dec. (°/')	Con.	Mag.	Type Object	Comments	Designation	R.A. (h/m)	Dec. (°/')	Con.	Mag.	Type Object	Comments
M1	0533	+2200	Tau	8	P. Neb.	*	M57	1853	+3300	Lyr	9	P. Neb.	*
M2	2132	-0058	Agr	6	Gl. Cl.		M58	1235	+1158	Vir	9	Sp. Gx.	
M3	1341	+2832	CVn	6	Gl. Cl.		M59	1241	+1148	Vir	10	El. Gx.	
M4	1622	-2627	Sco	6	Gl. Cl.		M60	1242	+1143	Vir	9	El. Gx.	
M5	1517	+0212	Ser	C	Gl. Cl.		M61	1220	+0438	Vir	10	Sp. Gx.	
M6	1738	-3212	Sco	5	Op. Cl.		M62	1659	-3005	Oph	7	Gl. Cl.	
M7	1752	-3448	Sco	5	Op. Cl.		M63	1315	+4211	CVn	10	Sp. Gx.	
M8	1802	-2420	Sgr	7	D. Neb.	*	M64	1255	+2141	Com	9	Sp. Gx.	*
M9	1717	-1829	Oph	7	Gl. Cl.		M65	1117	+1317	Leo	9	Sp. Gx.	*
M10	1656	-0404	Oph	7	Gl. Cl.		M66	1119	+1310	Leo	8	Sp. Gx.	*
M11	1849	-0618	Sct	6	Op. Cl.		M67	0849	+1155	Cnc	6	Op. Cl.	
M12	1646	-0154	Oph	7	Gl. Cl.		M68	1238	-2636	Hya	8	Gl. Cl.	
M13	1641	+3630	Her	6	Gl. Cl.	*	M69	1829	-3222	Sgr	9	Gl. Cl.	
M14	1736	-0314	Oph	8	Gl. Cl.	*	M70	1841	-3220	Sgr	10	Gl. Cl.	
M15	2132	+1202	Peg	6	Gl. Cl.		M71	1952	+1836	Sgr	9	Gl. Cl.	
M16	1817	-1347	Ser	6	Op. Cl.	*	M72	2052	-1239	Aqr	10	Gl. Cl.	
M17	1818	-1611	Sgr	8	D. Neb.	*	M73	—	—	—	—	—	—
M18	1818	-1708	Sgr	8	Op. Cl.		M74	0135	+1538	Psc	10	Sp. Gx.	
M19	1701	-2613	Oph	7	Gl. Cl.		M75	2004	-2201	Sgr	8	Gl. Cl.	
M20	1800	-2302	Sgr	6	D. Neb.	*	M76	0140	+5125	Per	12	P. Neb.	
M21	1803	-2230	Sgr	7	Op. Cl.		M77	0241	-0009	Cet	9	Sp. Gx.	
M22	1834	-2357	Sgr	6	Gl. Cl.		M78	0545	+0003	Ori	10	D. Neb.	
M23	1755	-1901	Sgr	7	Op. Cl.		M79	0523	-2433	Lip	8	Gl. Cl.	
M24	1817	-1826	Sgr	5	Op. Cl.		M80	1615	-2255	Sco	8	Gl. Cl.	
M25	1830	-1916	Sgr	6	Op. Cl.		M81	0954	+6912	UMa	8	Sp. Gx.	
M26	1844	-0926	Sct	9	Op. Cl.		M82	0954	+6950	UMa	9	Sp. Gx.	
M27	1958	+2238	Vul	8	P. Neb.	*	M83	1335	-2943	Hya	10	Sp. Gx.	
M28	1823	-2453	Sgr	7	Gl. Cl.		M84	1224	+1303	Vir	9	El. Gx.	
M29	2023	+3825	Cyg	7	Op. Cl.		M85	1224	+1821	Com	9	El. Gx.	
M30	2139	-2320	Cap	8	Gl. Cl.		M86	1225	+1306	Vir	10	El. Gx.	
M31	0041	+4107	And	5	Sp. Gx.	*	M87	1229	+1233	Vir	9	El. Gx.	
M32	0041	+4043	And	9	El. Gx.		M88	1231	+1435	Com	10	Sp. Gx.	
M33	0132	+3030	Tri	7	Sp. Gx.	*	M89	1234	+1243	Vir	10	El. Gx.	
M34	0240	+4239	Per	6	Op. Cl.		M90	1234	+1319	Vir	10	Sp. Gx.	
M35	0607	+2420	Gem	5	Op. Cl.	*	M91	—	—	—	—	—	—
M36	0533	+3408	Aur	6	Op. Cl.		M92	1717	+4311	Her	6	Gl. Cl.	
M37	0550	+3233	Aur	6	Op. Cl.		M93	0742	-2348	Pup	6	Op. Cl.	
M38	0550	+3549	Aur	7	Op. Cl.		M94	1250	+4117	CVn	8	Sp. Gx.	
M39	2132	+4818	Cyg	6	Op. Cl.		M95	1042	+1152	Leo	10	Sp. Gx.	
M40	—	—	—	—	—	—	M96	1045	+1159	Leo	9	Sp. Gx.	
M41	0646	-2044	CMa	5	Op. Cl.		M97	1113	+5512	UMa	12	P. Neb.	
M42	0534	-0524	Orion	6	D. Neb.	*	M98	1212	+1504	Com	11	Sp. Gx.	
M43	0534	-0517	Orion	9	D. Neb.		M99	1217	+1435	Com	10	Sp. Gx.	
M44	0838	+1948	Cnc	4	Op. Cl.	*	M100	1221	+1559	Com	11	Sp. Gx.	
M45	0345	+2404	Tau	2	Op. Cl.	*	M101	1402	+5429	UMa	10	Sp. Gx.	
M46	0741	-1445	Pup	6	Op. Cl.		M102	1506	+5557	Dra	11	Sp. Gx.	
M47	—	—	—	—	—	—	M103	0131	+6033	Cas	7	Op. Cl.	
M48	0812	-0148	Hya	6	Op. Cl.		M104	1238	-1128	Vir	9	Sp. Gx.	*
M49	1228	+0809	Vir	9	El. Gx.		M105	1046	+1245	Leo	9	Sp. Gx.	
M50	0702	-0818	Mon	6	Op. Cl.		M106	1218	+4728	CVn	7	Sp. Gx.	
M51	1329	+4721	CVn	8	Sp. Gx.	*	M107	1631	-1259	Oph	9	Gl. Cl.	
M52	2323	+6126	Cas	7	Op. Cl.		M108	1110	+5551	UMa	10	Sp. Gx.	
M53	1312	+1820	Com	8	Gl. Cl.		M109	1156	+5332	UMa	11	Sp. Gx.	
M54	1853	-3031	Sgr	8	Gl. Cl.								
M55	1938	-3100	Sgr	5	Gl. Cl.								
M56	1916	+3007	Lyr	8	Gl. Cl.								

\*Denotes well-known objects of special interest.

Appendix IV  
Alphabetical Listing of Bright Stars

Star	Constellation	Apparent Magnitude	Coordinates		Star	Constellation	Apparent Magnitude	Coordinates	
			R.A. (h/m)	Dec. (°/')				R.A. (h/m)	Dec. (°/')
Achernar	Eridanus	0.6	0137	-5724	Fomalhaut	Piscis Aust.	1.3	2256	-2947
Acrux	Crux	1.4	1225	-6259	Pollux	Gemini	1.2	0743	+2805
Aldebaran	Taurus	1.1	0434	+1627	Procyon	Canis Minor	0.5	0738	+0518
Altair	Aquila	0.9	1949	+0847	Regulus	Leo	1.3	1007	+1208
Antares	Scorpius	1.2	1628	-2622	Rigel	Orion	0.3	0513	-0814
Arcturus	Bootes	0.2	1414	+1921	Rigel Kent	Centaurus	0.1	1438	-6043
Bellatrix	Orion	1.7	0524	+0619	Sirius	Canis Major	-1.6	0644	-1640
Betelgeuse	Orion	0.1	0554	+0724	Spica	Virgo	1.2	1323	-1100
Canopus	Carina	-0.9	0623	-5241	Tureis	Carina	2.2	0916	-5909
Capella	Auriga	0.2	0514	+4558	Vega	Lyra	0.1	1836	+3836
Deneb	Cygnus	1.3	2040	+4510					

Appendix V  
C11 Eyepiece Reference Table  
With Tele-Extender (values rounded off!)

Ocular Focal Length	Barrel Diameter	Visual Magnification	Exit Pupil (mm)	Effective Focal Length	f/Number	Photographic Magnification (compared to 50mm lens)
12mm	1 1/4"	233	1.2	39,700	142	794
16mm	1 1/4"	175	1.6	29,800	106	596
18mm	1 1/4"	156	1.8	23,300	83	466
20mm	1 1/4"	140	2.0	21,000	75	420
25mm	1 1/4"	112	2.5	16,800	60	280
32mm	1 1/4"	88	3.2	13,100	47	262
40mm	1 1/4"	70	4.0	10,500	38	210
These eyepieces not intended for Tele-Extender Use						
4mm	1 1/4"	700	.4	—	—	—
5mm	1 1/4"	560	.5	—	—	—
6mm	1 1/4"	467	.6	—	—	—
7mm	1 1/4"	400	.7	—	—	—
9mm	1 1/4"	311	.9	—	—	—
24mm	1 1/4"	167	2.4	—	—	—
28mm	1 1/4"	100	2.8	—	—	—
Zoom	1 1/4"	333-133	8-2.1	—	—	—
70mm	2"	40	7.0	—	—	—
60mm	2"	47	6.0	—	—	—
50mm	2"	56	5.0	—	—	—
40mm	2"	70	4.0	—	—	—
32mm	2"	88	3.2	—	—	—
25mm	2"	112	2.5	—	—	—
18mm	2"	155	1.8	—	—	—

**Appendix VI**  
**C14 Eyepiece Reference Table**  
 With Tele-Extender (values rounded off)

Ocular Focal Length	Barrel Diameter	Visual Magnification	Exit Pupil (mm)	Effective Focal Length	f/Number	Photographic Magnification (compared to 50mm lens)
12mm	1 1/4"	326	1.1	55,400	158	1,110
16mm	1 1/4"	244	1.4	41,500	118	830
18mm	1 1/4"	217	1.6	35,560	100	710
20mm	1 1/4"	196	1.8	29,300	84	590
25mm	1 1/4"	156	2.3	23,500	67	470
32mm	1 1/4"	122	2.9	18,300	52	370
40mm	1 1/4"	98	3.6	14,700	42	290

These eyepieces not intended for Tele-Extender Use

4mm	1 1/4"	978	.36	--	--	--
5mm	1 1/4"	782	.45	--	--	--
6mm	1 1/4"	652	.54	--	--	--
7mm	1 1/4"	558	.64	--	--	--
9mm	1 1/4"	434	.82	--	--	--
24mm	1 1/4"	162	2.2	--	--	--
28mm	1 1/4"	140	2.5	--	--	--
Zoom	1 1/4"	186-465	1.9-.76	--	--	--
70mm	2"	56	6.4	--	--	--
60mm	2"	65	5.4	--	--	--
50mm	2"	78	4.5	--	--	--
40mm	2"	98	3.6	--	--	--
32mm	2"	122	2.9	--	--	--
25mm	2"	156	2.3	--	--	--
18mm	2"	248	1.6	--	--	--

**Appendix VII**  
**Recommended Reading**

Numerous excellent works are available in the fields of astronomy or photography from the following publishers or distributors:

Eastman Kodak Company, Dept. 454  
 Rochester, New York 14650

Ask for "Index to Kodak Information"

Herbert A. Luft  
 69-11 229th St.

Oakland Gardens, New York 11364

Ask for "List of Astronomical Literature."

Sky Publishing Corporation

49-50-51 Bay State Rd.

Cambridge, Mass. 02138 617/864-7360

Ask for "Scanning the Skies."

The California Institute of Technology  
 Bookstore 1-51

Pasadena, CA 91125

Sells astronomical slides and posters.

**MAGAZINES**

*Astronomy*

411 E. Mason St., 6th Flr.

Milwaukee, WI 53202 414/276-2689

*Sky & Telescope*

Sky Publishing Corp.

49-50-51 Bay State Rd.

Cambridge, Mass. 02138 617/864-7360

*Mercury*

Astronomical Society of the Pacific

1290 24th Avenue

San Francisco, CA 94122 415/661-8660

(Also lists nation-wide astronomy clubs with excellent local contacts and lists of various educational materials.)

*Telescope Making*

Astro Media Corp.

411 E. Mason St.

P.O. Box 92788

Milwaukee, WI 53202 414/276-2689

*Science News*

Subscription Department

231 West Center Street

Marion, OH 43301 1-800/247-2160

**STAR GUIDES & ATLASES**

Burnham's Celestial Handbook

3 vol.; Dover Press; very informative

Norton's Star Atlas

(available through Sky Publishing Corp.)

Atlas of Deep Sky Splendors

by Hans Vehrenberg

(available through Sky Publishing Corp.)

Atlas of the Heavens

by Antonin Becvar

(available through Sky Publishing Corp.)

**Appendix VIII**

**Observatory Dome Suppliers**

Ash Manufacturing Company, Inc.

P.O. Box 312

Plainfield, Ill. 60544

815/436-9403

Observa-Dome Laboratories, Inc.

371 Commerce Park Drive

P.O. Box 885

Jackson, MS. 39205

800/647-5364

**Appendix IX**  
**Celestron 11/14**  
**Permanent Pier Plans**

